

Appendix 5 - ATM Technology in Detail

ATM Technology

Asynchronous Transfer Mode
Principles, ATM Layering, AAL, Signaling

Agenda

- **Introduction**
- **ATM Reference Model**
- **Physical Layer**
- **ATM Layer**
- **ATM Switching Details**
- **ATM Adaptation Layer**
- **ATM Signaling and Addressing**

© 2007, D.I. Manfred LindnerATM Technology, v4.22

Appendix 5 - ATM Technology in Detail

Introduction

- **In 1986 the CCITT (now ITU-T) adopted ATM as background technology for B-ISDN**
 - B-ISDN intended to replace several widespread incompatible technologies
 - integration of voice, video and data
 - However, the data communications industry tried to push IEEE 802.6 - DQDB
 - remark: N-ISDN is based on synchronous TDM
- **First developments in 1988 by CCITT**
- **ATM Forum established in 1991**
 - Focuses on implementation rules for ATM
 - Most members were switch manufacturers

© 2007, D.I. Manfred Lindner

ATM Technology, v4.2

3

What is ATM?

- **ATM**
 - Asynchronous Transfer Mode
 - Based on asynchronous TDM
 - hence buffering and address information is necessary
- **Cell switching technology**
 - based on store-and-forward of cells
 - a form of packet switching
 - connection oriented type of service with virtual circuits
- **ATM cell**
 - small packet with constant length
 - 53 bytes long
 - 5 bytes header + 48 bytes data

© 2007, D.I. Manfred Lindner

ATM Technology, v4.2

4

Appendix 5 - ATM Technology in Detail

What is Asynchronous Transfer Mode?

Synchronous TDM	Asynchronous TDM
(+) Constant delay (good for voice)	(-) Variable delay (variable frame sizes)
(+) Protocol transparent	(+/-) Fairly protocol transparent
(-) Fixed channel assignment (might be uneconomic)	(+) Flexible channel assignment (using addresses)
(-) Trunk bandwidth = sum of channel speeds (expensive)	(+) Trunk bandwidth = average of channel speeds

Asynchronous Transfer Mode (ATM)

- (+) Bounded delay through fixed cell sizes (53 bytes) and intelligent traffic management based on different traffic classes
- (+) Protocol transparent through higher layers (CPCS and SAR)
- (+) Flexible channel assignment using addresses (VPI/VCI)
- (+) Trunk bandwidth according average channel speeds

© 2007, D.I. Manfred Lindner
ATM Technology, v4.2
5

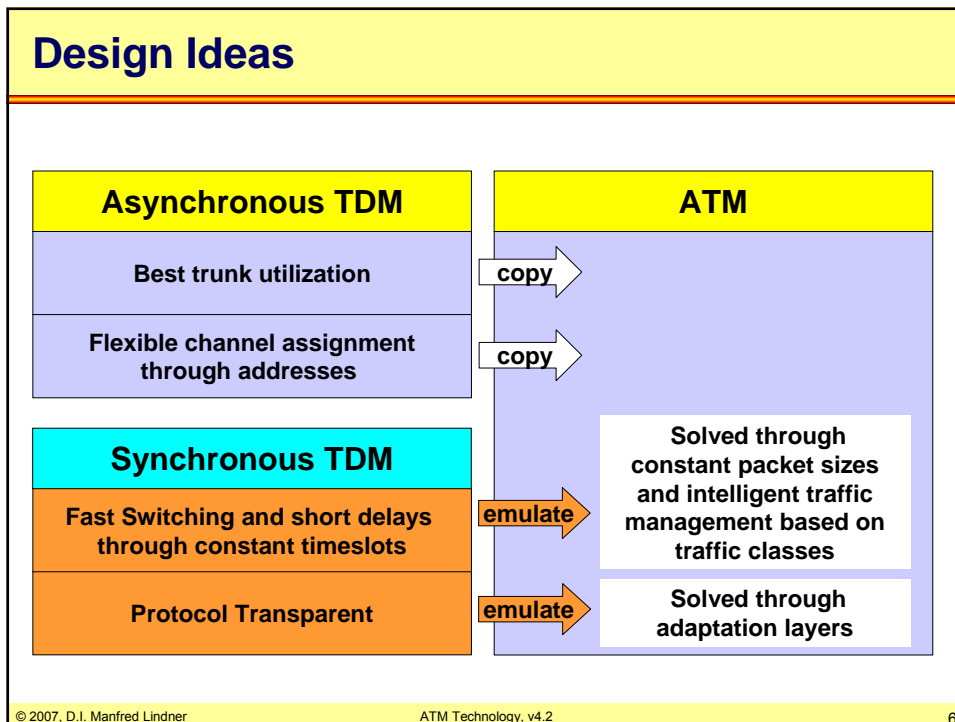

Appendix 5 - ATM Technology in Detail

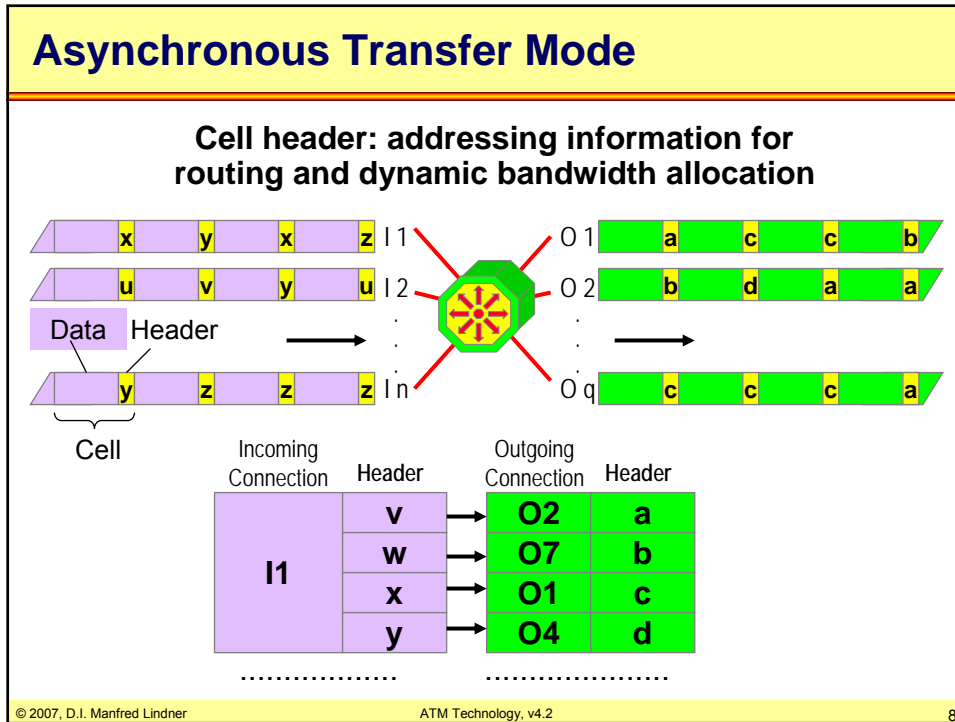
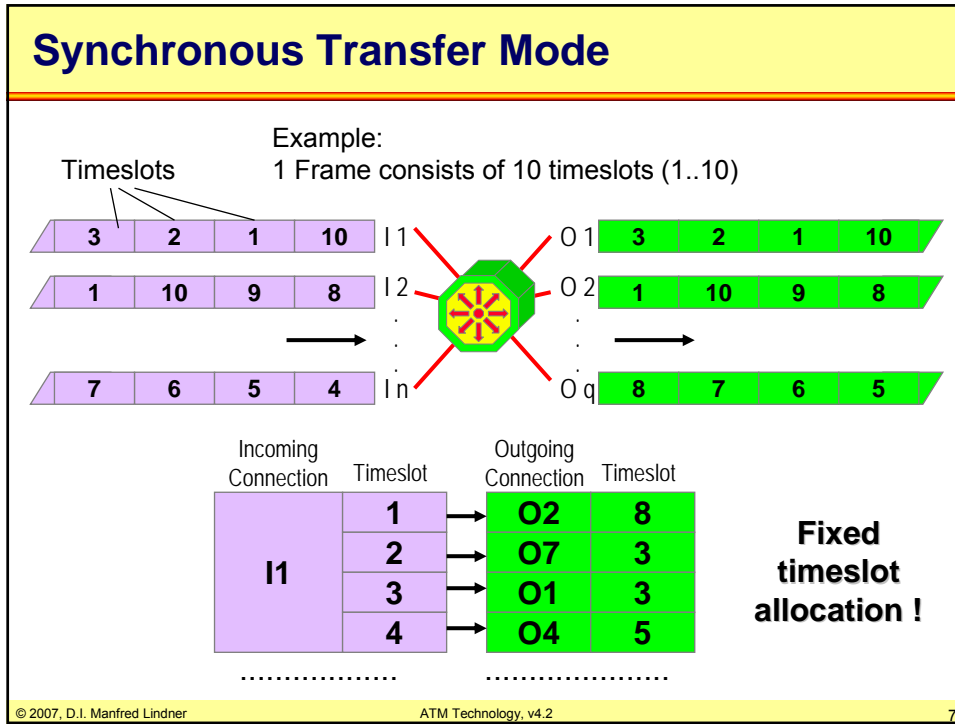

Appendix 5 - ATM Technology in Detail

Why Cells?

- **Cell switching technology allows**
 - Forwarding of cells in hardware
 - Hence very fast
 - Predictable and bounded delay for a given cell
 - It is still variable!
 - Quality of Service (QoS)
 - With specific strategies like admission control, QOS routing, traffic shaping, traffic policing, cell scheduling,
 - Integration of voice, video and data
 - Real-time traffic and non real-time traffic on the same network infrastructure

© 2007, D.I. Manfred Lindner

ATM Technology, v4.2

9

Cell Switching and Jitter

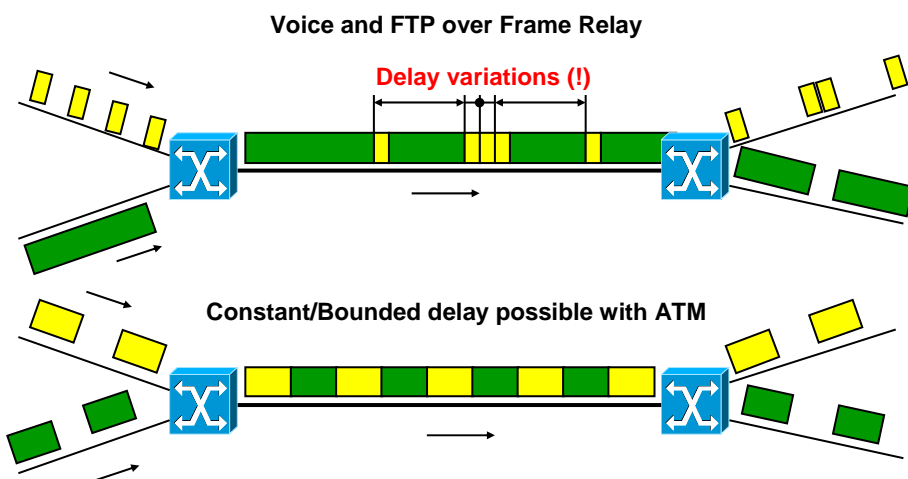

© 2007, D.I. Manfred Lindner

ATM Technology, v4.2

10

Appendix 5 - ATM Technology in Detail

ATM Technology

- **WAN service and (campus area network service)**
 - Based on virtual circuit technique
 - Connection oriented, enables charging for carriers and providers
 - Sequencing of cell stream is guaranteed but no error recovery is done for damaged cells
 - One single technology to cover both WAN and LAN (MAN) aspects
- **Standardized interface definitions**
 - User Network Interface (UNI)
 - between ATM-DTE and ATM-DCE
 - Network Node Interface (NNI)
 - between ATM-DCE and ATM-DCE

© 2007, D.I. Manfred Lindner

ATM Technology, v4.2

11

ATM Basic Topology

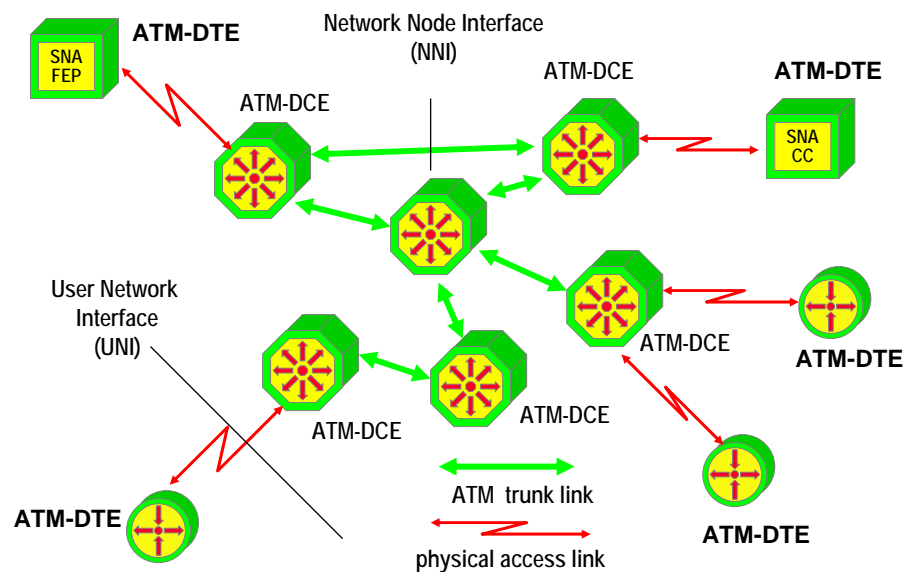

© 2007, D.I. Manfred Lindner

ATM Technology, v4.2

12

Appendix 5 - ATM Technology in Detail

ATM Virtual Circuits

- **Virtual circuit technique used**
 - For statistically multiplexing many logical conversations over a single physical transmission link
- **End systems (ATM-DTE) use virtual circuits for delivering data to the ATM network and vice versa**
- **Virtual circuits appear to end systems as transparent transport pipes**
 - Logical point-to-point connections

© 2007, D.I. Manfred Lindner

ATM Technology, v4.2

13

ATM Virtual Circuits

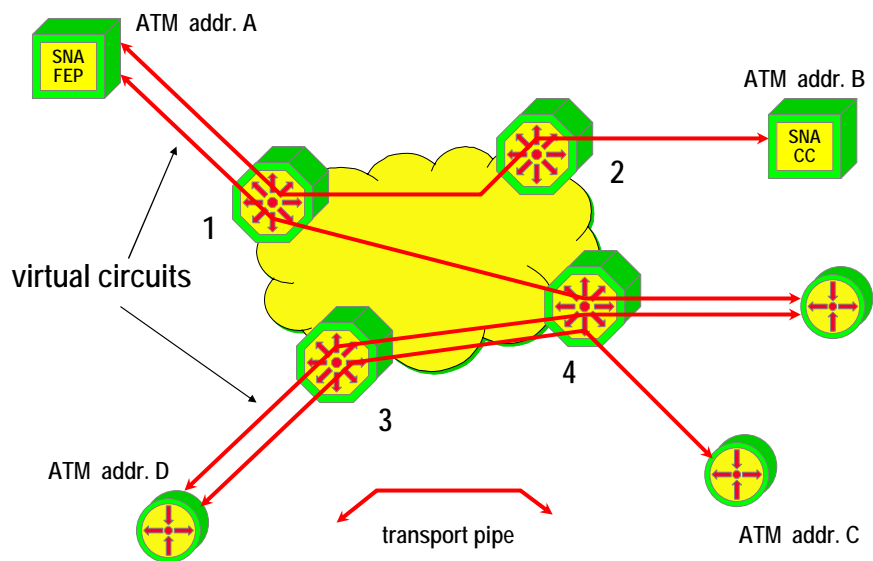

© 2007, D.I. Manfred Lindner

ATM Technology, v4.2

14

Appendix 5 - ATM Technology in Detail

ATM VPI / VCI

- **Virtual circuits (VCs) are identified using VPI / VCI numbers**
 - Virtual Path Identifier / Virtual Channel Identifier
 - Only locally significant
- **Two kinds of virtual circuits**
 - Permanent virtual circuits (ATM-PVC) established in advance by service provider
 - Switched virtual circuits (ATM-SVC) established on demand by user through signaling procedure

© 2007, D.I. Manfred Lindner

ATM Technology, v4.2

15

VPI / VCI

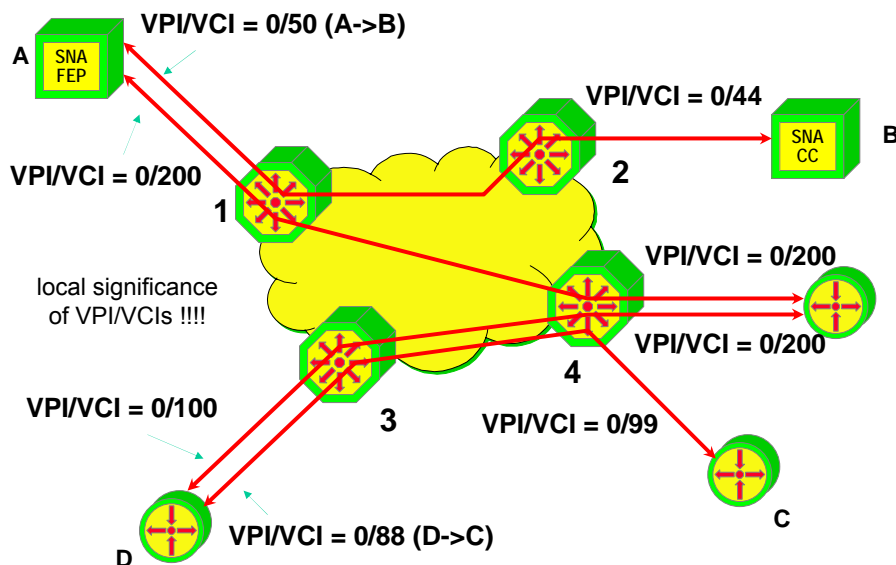

© 2007, D.I. Manfred Lindner

ATM Technology, v4.2

16

Appendix 5 - ATM Technology in Detail

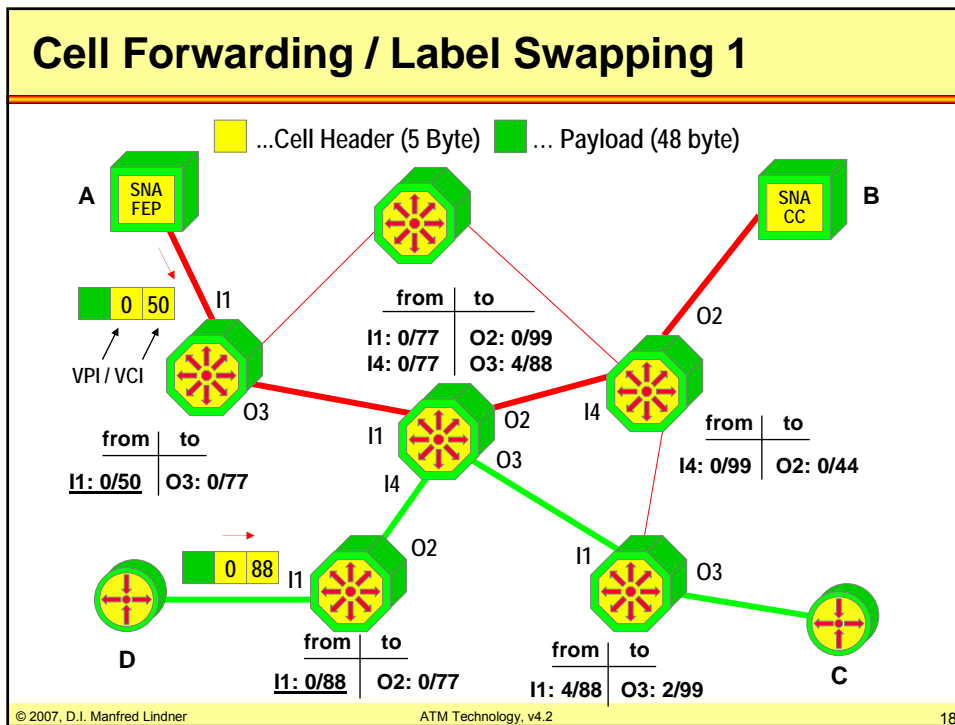
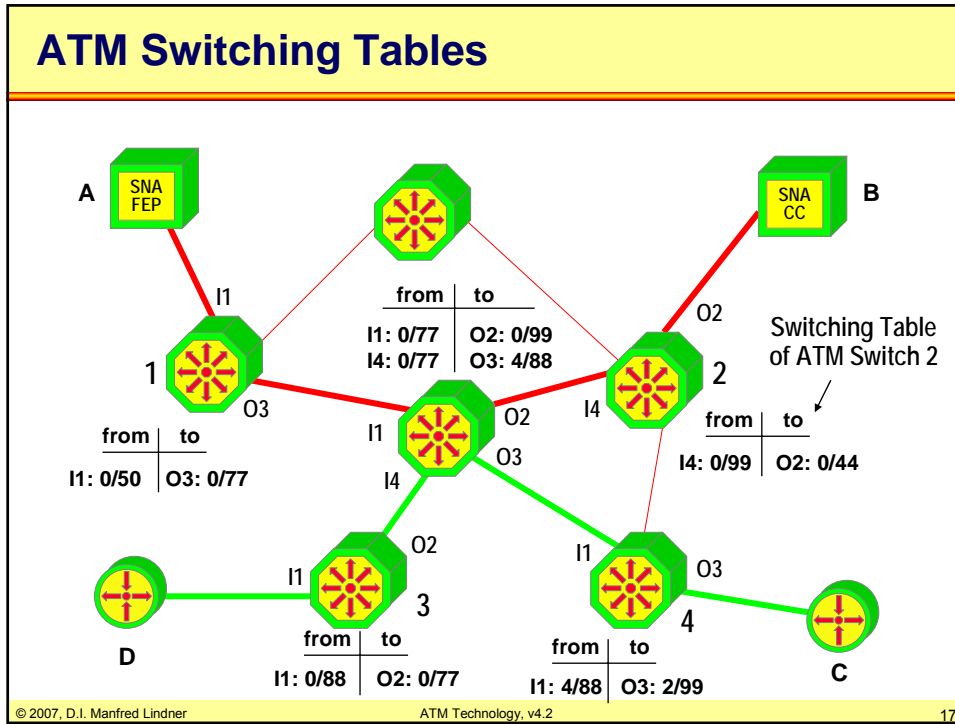

Appendix 5 - ATM Technology in Detail

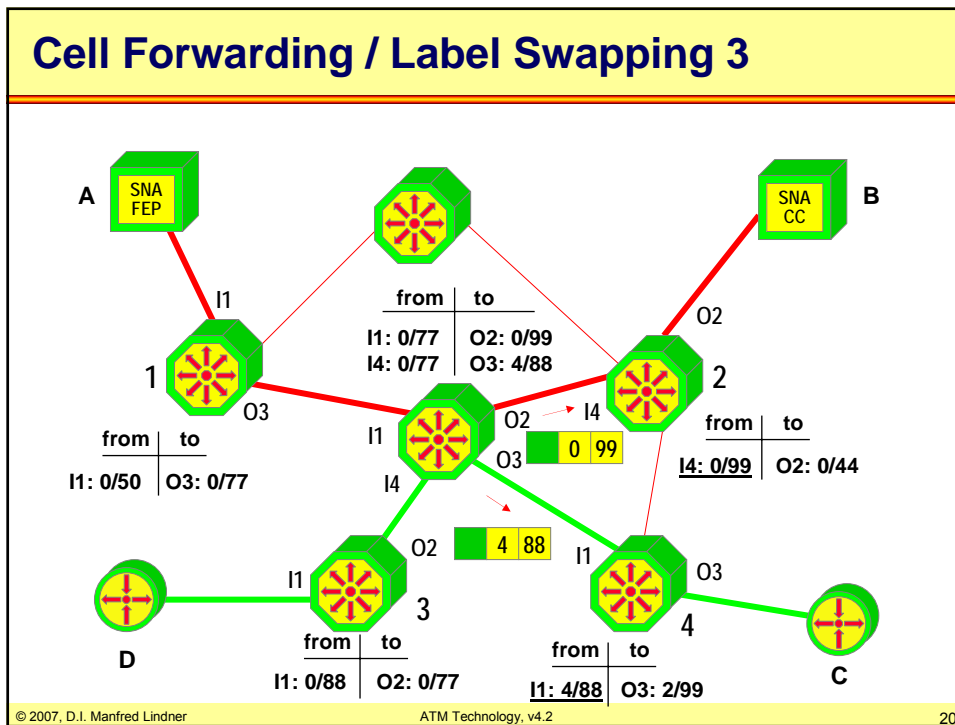
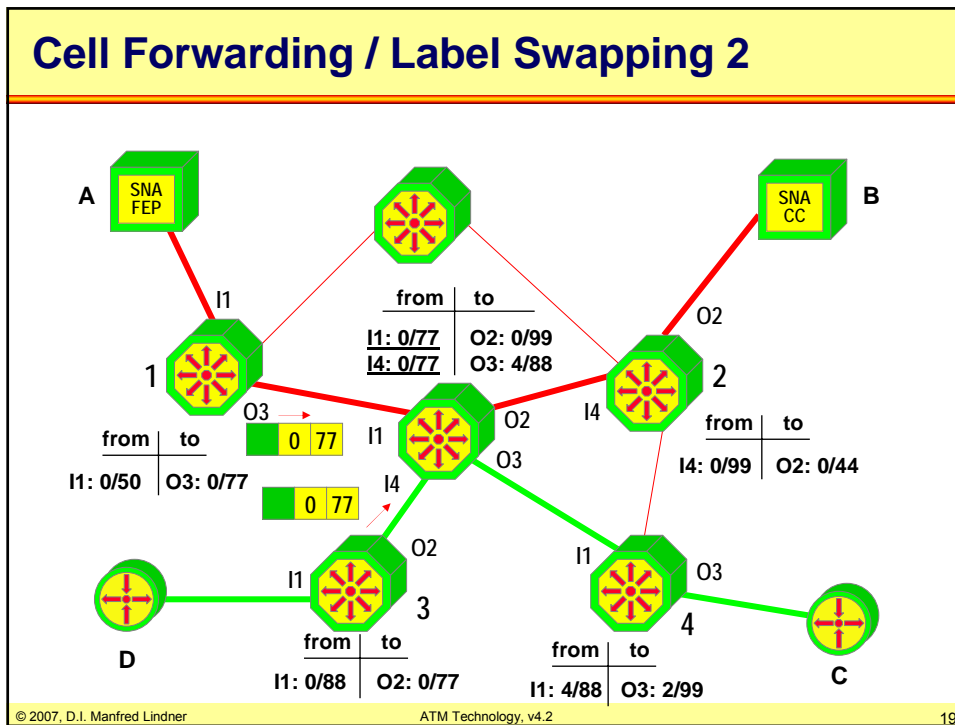

Appendix 5 - ATM Technology in Detail

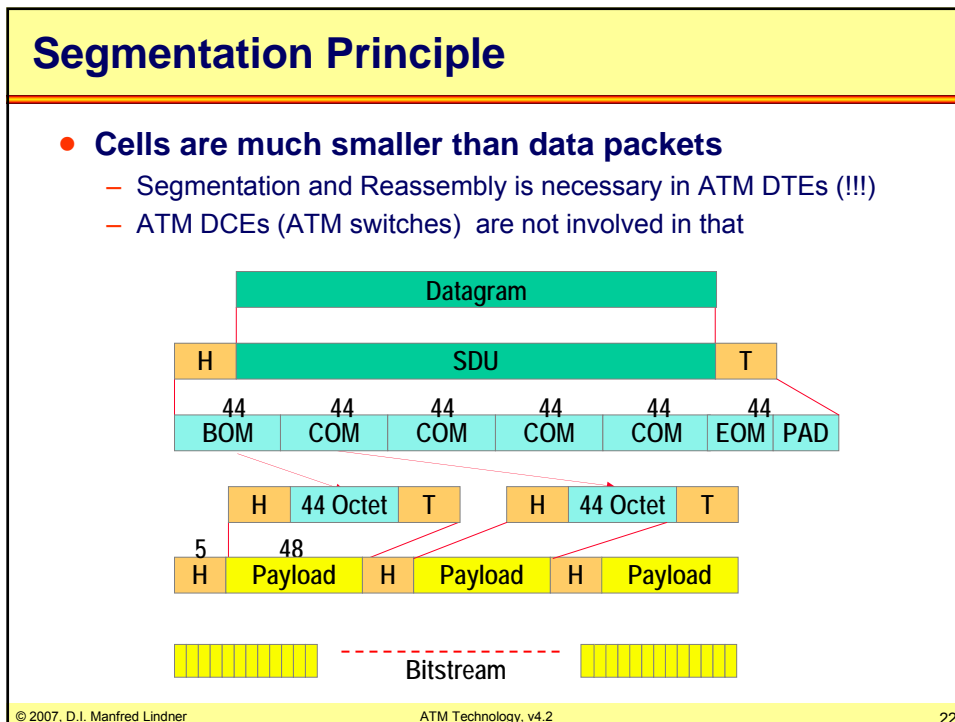
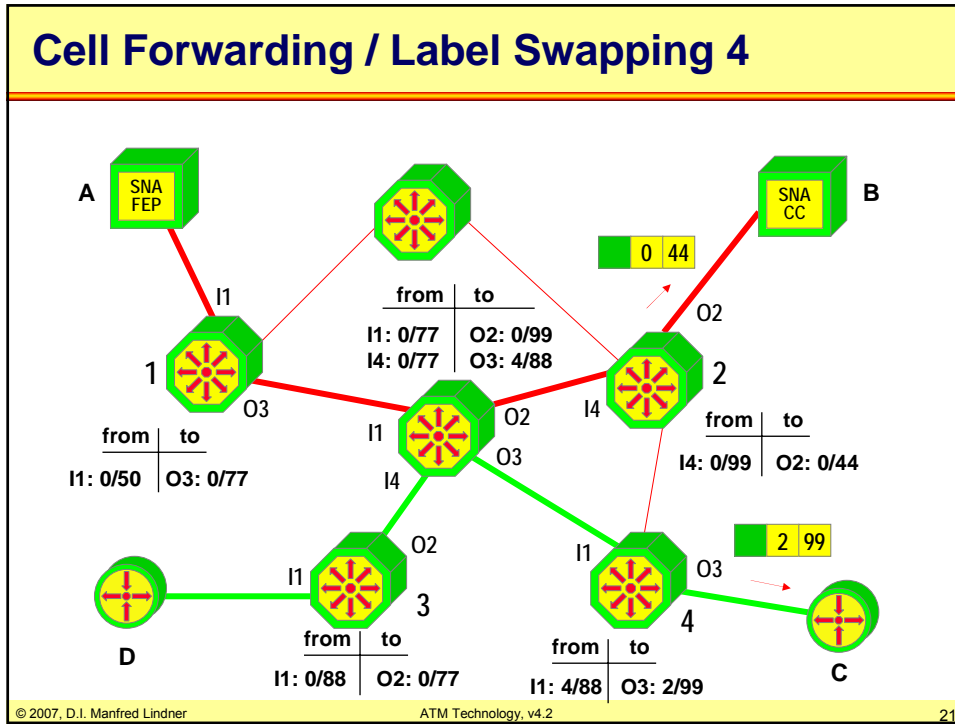

Appendix 5 - ATM Technology in Detail

ATM Usage

- **Public and private networks**
 - LAN, MAN, WAN
- **Backbone high-speed networks**
 - Public (Telco's) or private
- **Original goal: World-wide ATM network**
 - But Internet technology and state-of-the art Ethernet are more attractive today
- **New importance as backbone technology for mobile applications**
 - Cellular networks for GSM, GPRS, UMTS, ...

© 2007, D.I. Manfred Lindner

ATM Technology, v4.2

23

ATM as WAN Technology based on SDH

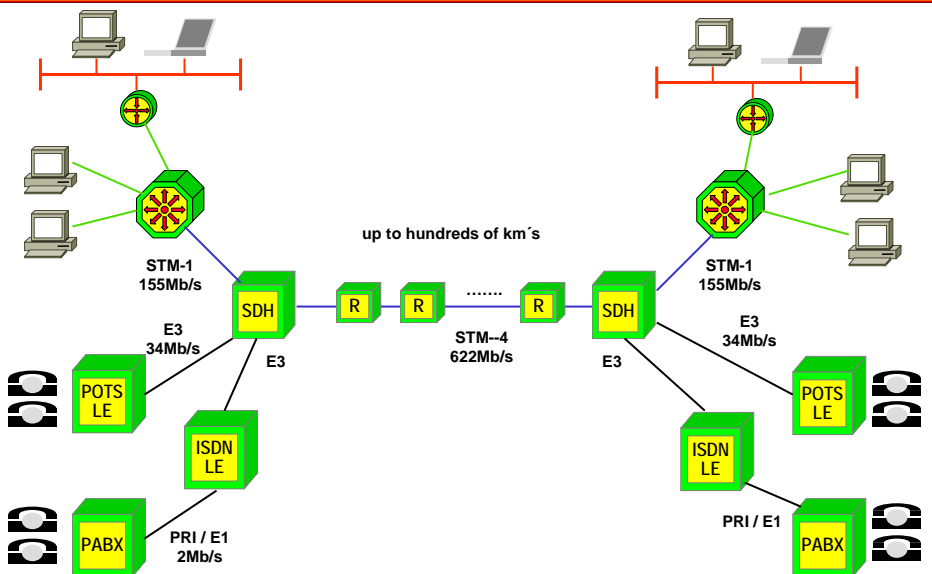

© 2007, D.I. Manfred Lindner

ATM Technology, v4.2

24

Appendix 5 - ATM Technology in Detail

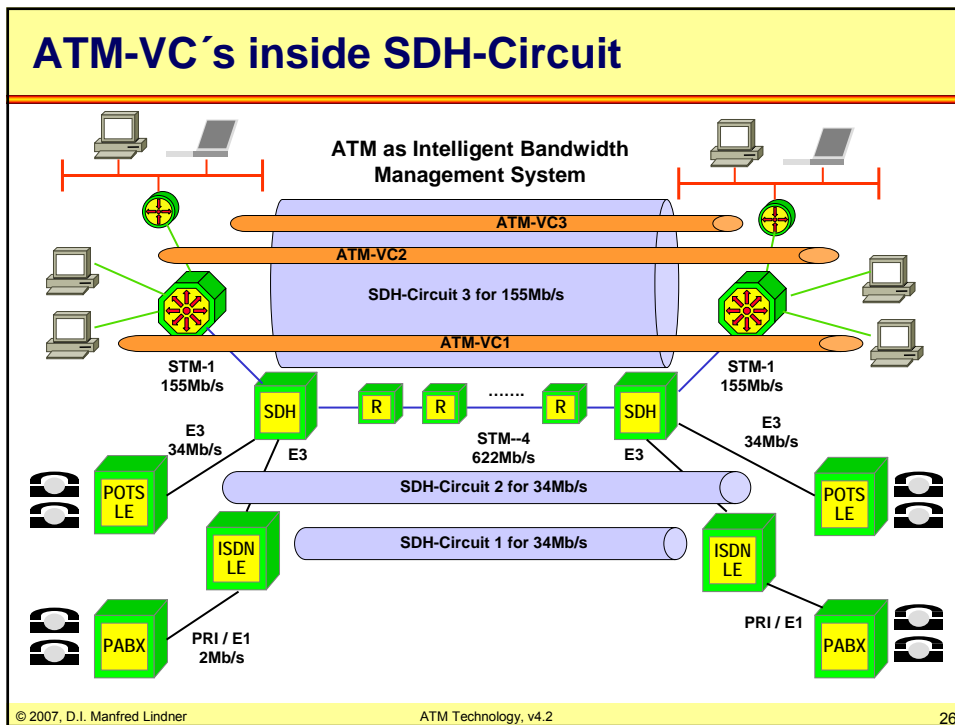
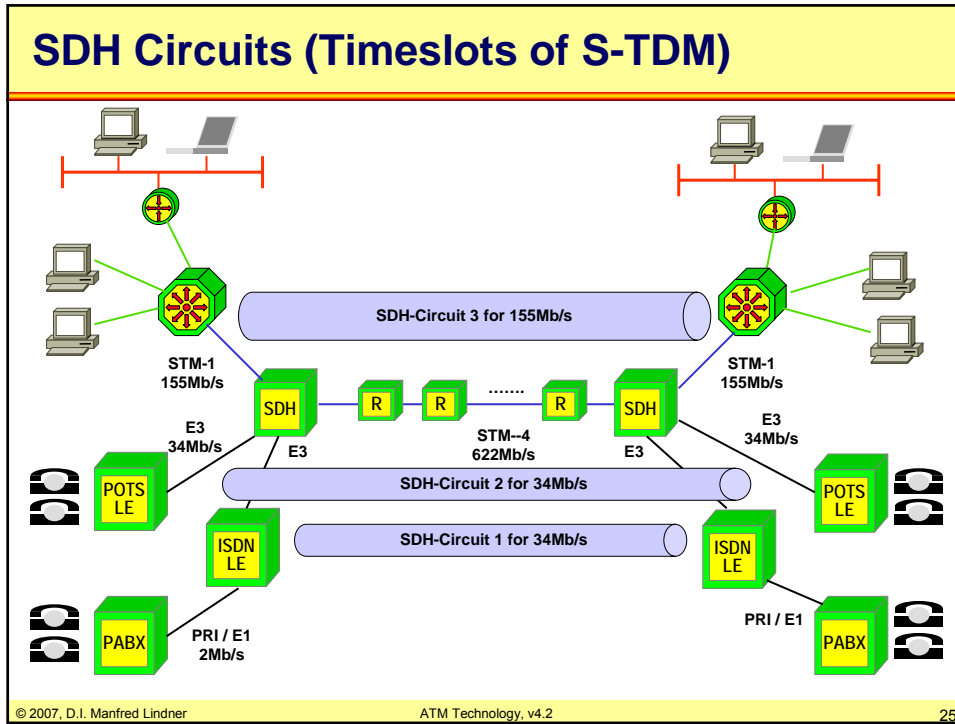

Appendix 5 - ATM Technology in Detail

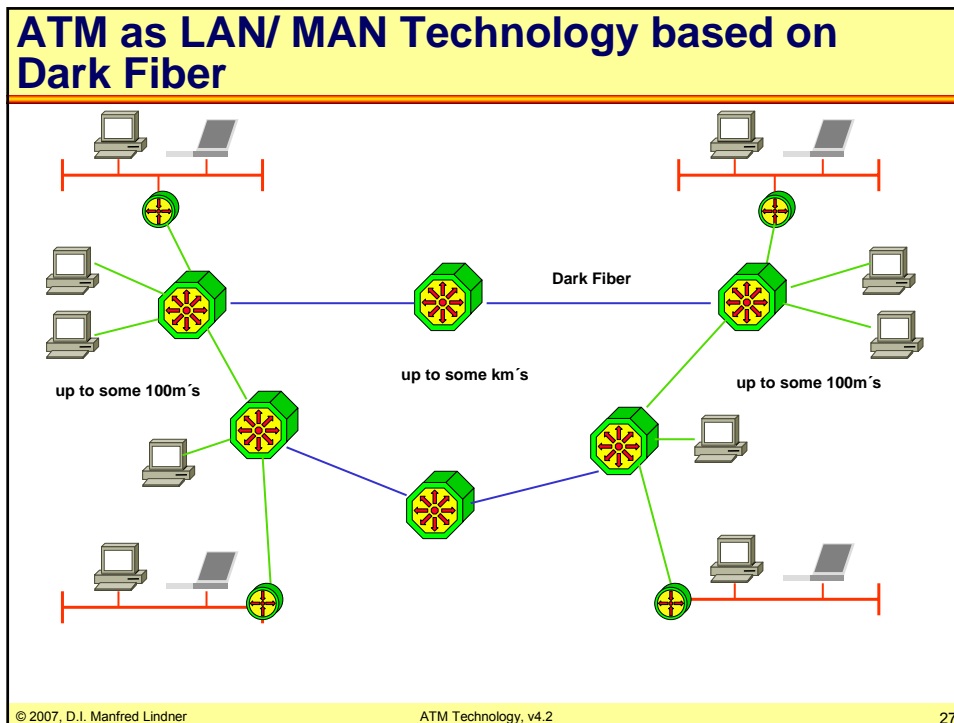

Standardization Responsibilities

- **Private ATM networks: ATM Forum**
 - Private UNI
 - Addressing similar to OSI NSAP addresses
 - Private NNI
 - Dynamic routing based on Link State Technique (PNNI)
- **Public ATM networks: ITU-T**
 - Public UNI
 - Addressing based on E.164 addressing schema
 - Public NNI
 - Static routing

Appendix 5 - ATM Technology in Detail

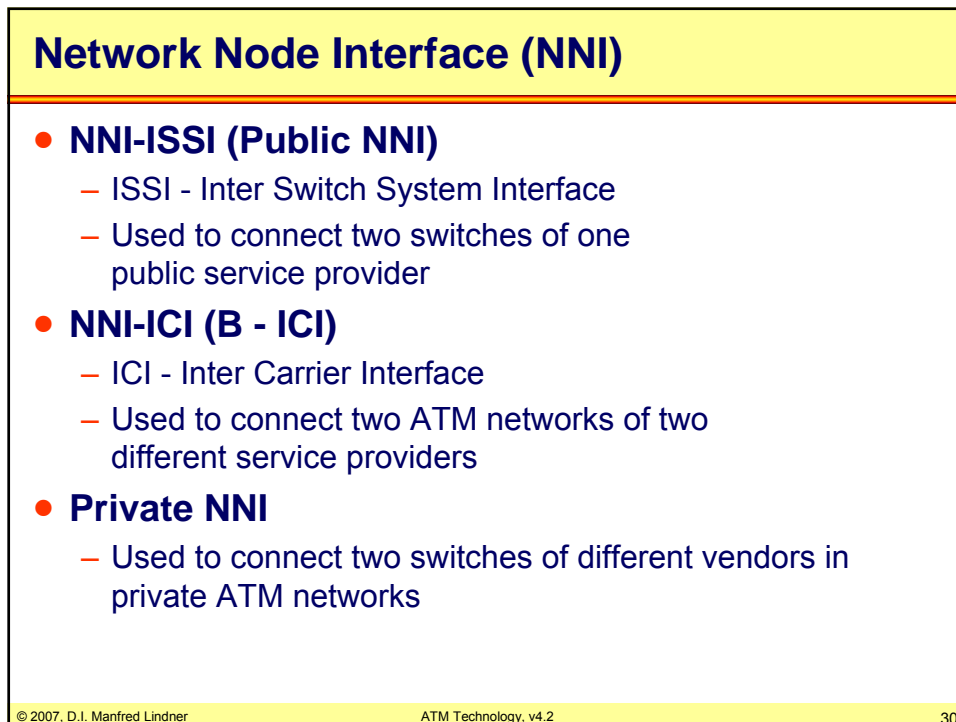
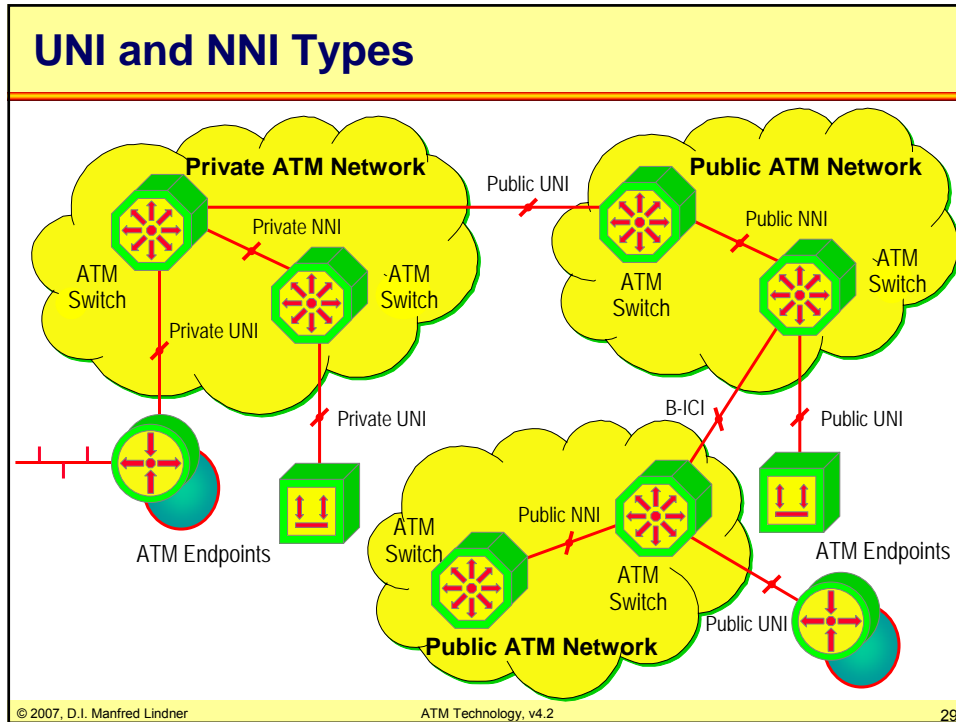

Appendix 5 - ATM Technology in Detail

Agenda

- Introduction
- ATM Reference Model
- Physical Layer
- ATM Layer
- ATM Switching Details
- ATM Adaptation Layer
- ATM Signaling and Addressing

ATM Reference Model

- **User Plane**
 - Provides for transfer of information
- **Control Plane**
 - Call control (Signaling) , connection control, PVC management, interim local management interface (e.g. ILMI)
- **Management Plane**
 - Layer management
 - e.g. meta-signaling, layer specific Operation and Maintenance (OAM) information flow
 - Plane management
 - Management functions related to the whole system
 - Coordination between all planes

Appendix 5 - ATM Technology in Detail

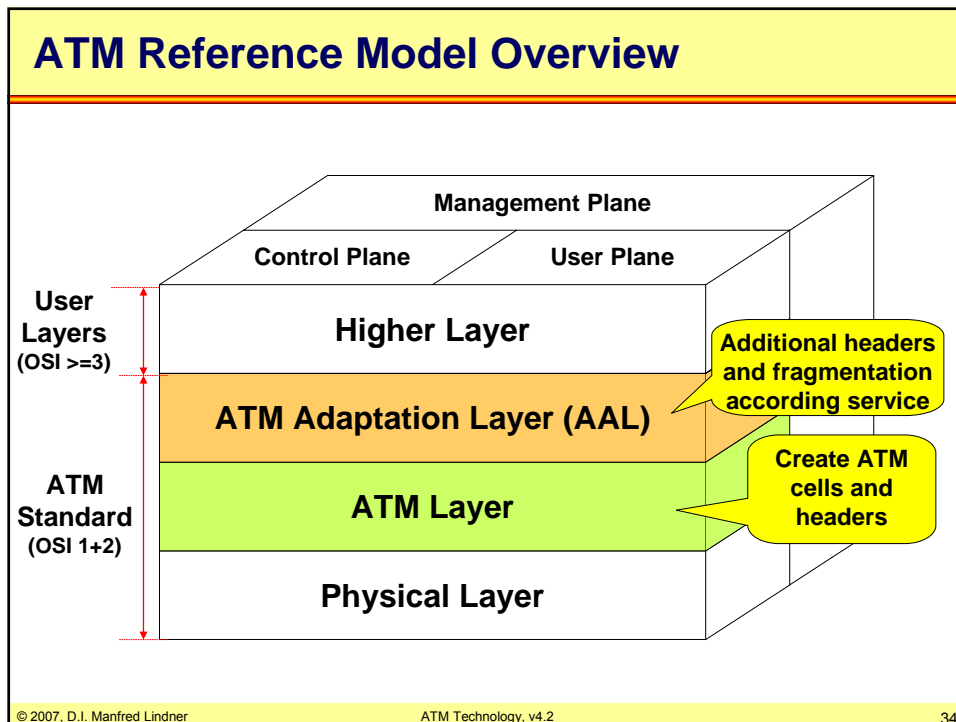
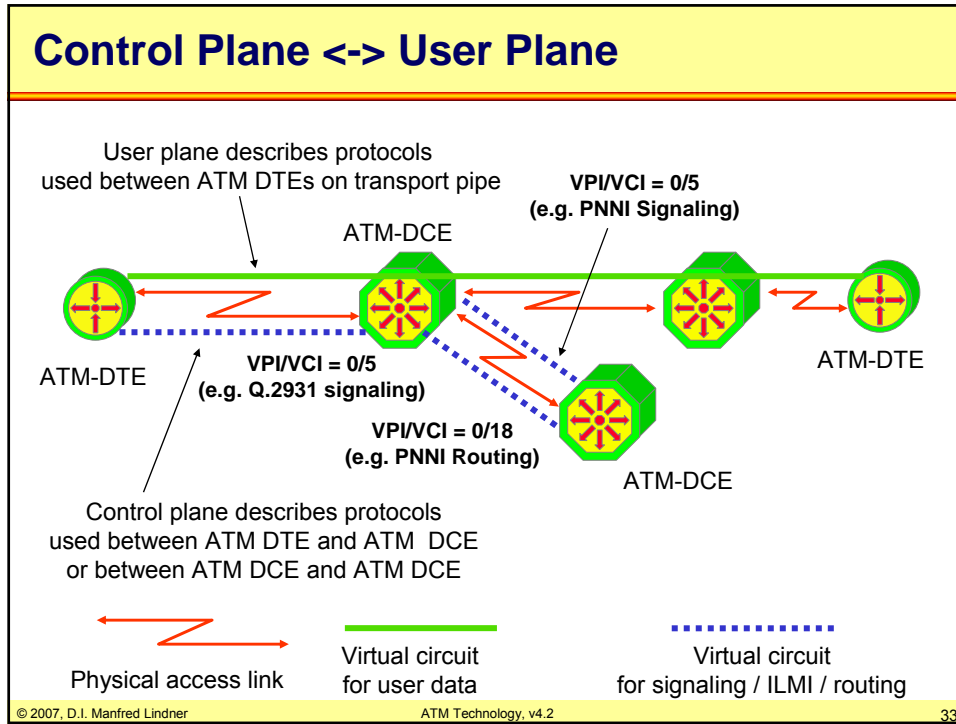

Appendix 5 - ATM Technology in Detail

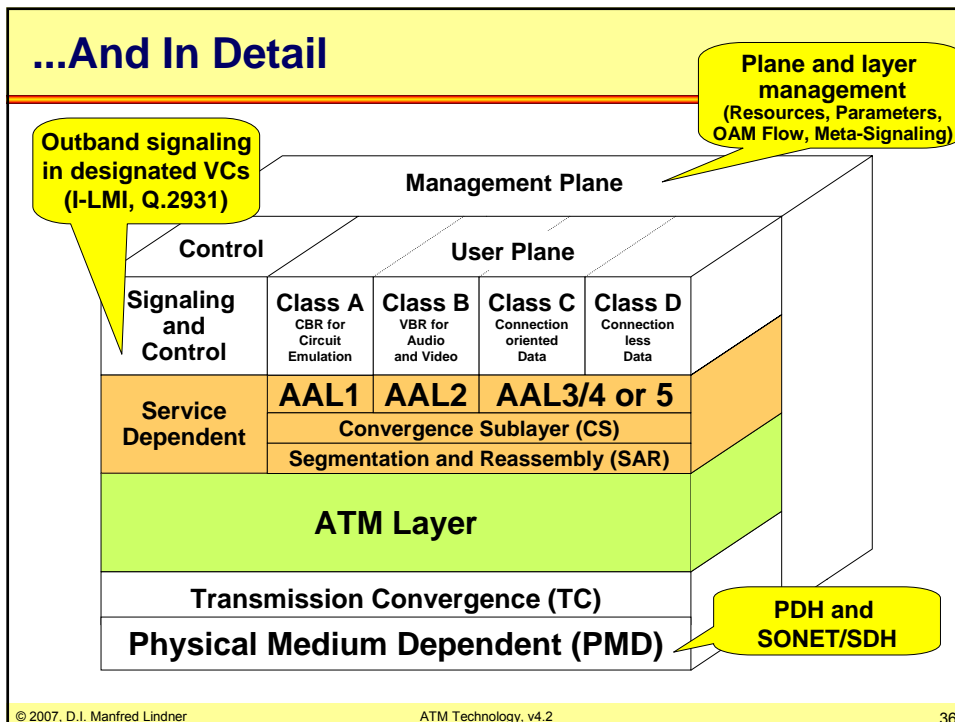
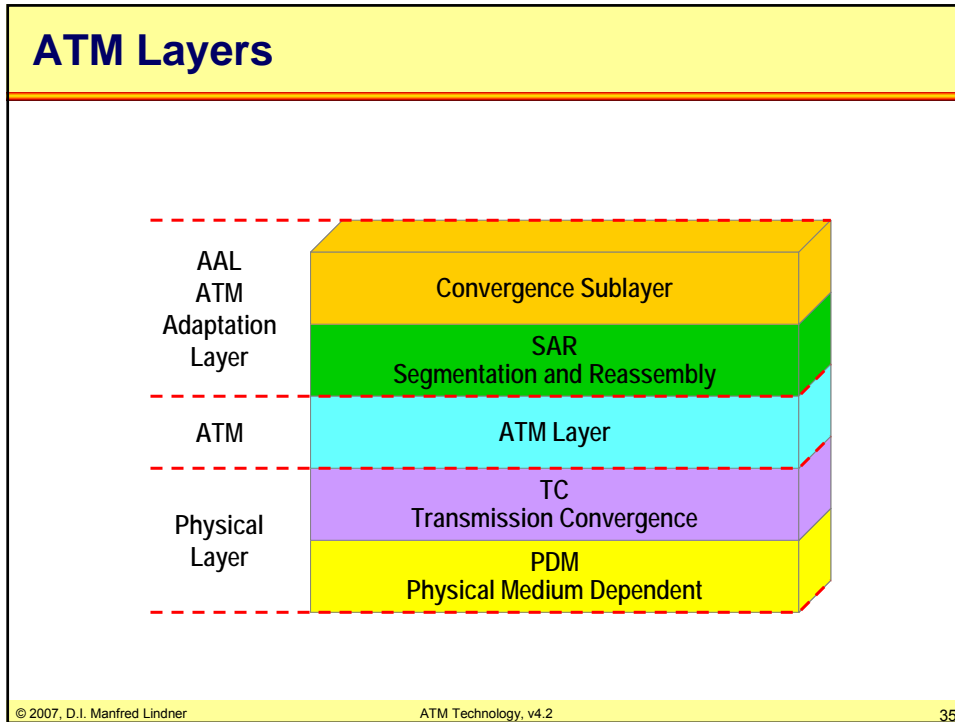

Appendix 5 - ATM Technology in Detail

Agenda

- Introduction
- ATM Reference Model
- Physical Layer
- ATM Layer
- ATM Switching Details
- ATM Adaptation Layer
- ATM Signaling and Addressing

Physical Layer

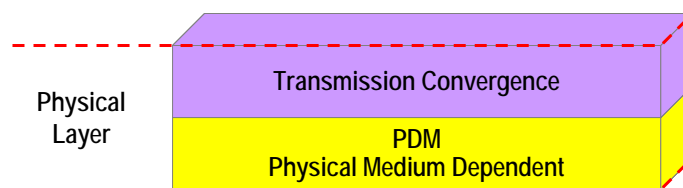

- **Subdivided into PMD Layer and Transmission Convergence Sublayer**
- **Allows easy exchange of the physical medium**
 - can be adapted to newest transmission technology

Appendix 5 - ATM Technology in Detail

PMD Sublayer

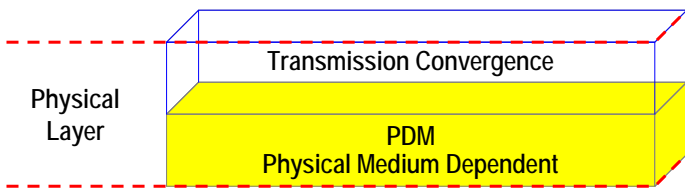

The diagram shows a 3D rectangular box representing the PMD sublayer. The top surface is labeled 'Transmission Convergence' and the bottom surface is labeled 'PDM Physical Medium Dependent'. To the left of the box, a dashed red line is labeled 'Physical Layer'.

- **Bit transmission capability, bit alignment**
(Bit-synchronization, Clock-synchronization)
- **Line coding**
- **Electrical/optical conversion**
- **A lot of different media have been specified in various standard documents**

© 2007, D.I. Manfred Lindner ATM Technology, v4.2 39

Transmission Convergence Sublayer

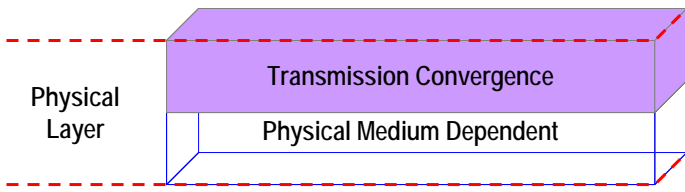

The diagram shows a 3D rectangular box representing the Transmission Convergence sublayer. The top surface is labeled 'Transmission Convergence' and the bottom surface is labeled 'Physical Medium Dependent'. To the left of the box, a dashed red line is labeled 'Physical Layer'.

<ul style="list-style-type: none"> ● Adaptation to different transmission systems (i.e. SDH, PDH, SONET, dark fiber) ● Generation and recovery of the transmission frame (e.g. PDH, SDH framing) ● Transmission frame adaptation 	<ul style="list-style-type: none"> ● Cell delineation (recovery of cell boundaries -> frame synchronization) ● HEC (Header Error Check) generation ● Cell rate decoupling (user cell rate versus needed synchronous cell rate)
--	---

© 2007, D.I. Manfred Lindner ATM Technology, v4.2 40

Appendix 5 - ATM Technology in Detail

Some Available Interfaces

Standard	Speed	Medium	Comments	Encoding	Connector	Usage
SDH STM-1	155,52	Coax	75 Ohm	CMI	BNC	WAN
PDH E4	139,264	Coax	75 Ohm	CMI	BNC	WAN
PDH DS3	44,736	Coax	75 Ohm	B3ZS	BNC	WAN
PDH E3	34,368	Coax	75 Ohm	HDB3	BNC	WAN
PDH E2	8,448	Coax	75 Ohm	HDB3	BNC	WAN
PDH J2	6,312	TP/Coax	110/75 Ohm	B6ZS/B8ZS	RJ45/BNC	WAN
PDH E1	2,048	TP/Coax	120/75 Ohm	HDB3	9pinD/BNC	WAN
PDH DS1	1,544	TP	100 Ohm	AM/B8ZS	RJ45/RJ48	WAN
SDH STM-4	622,08	SM fiber		SDH	SC	LAN/WAN
SDH STM-1	155,52	SM fiber		SDH	ST	LAN/WAN
SDH STM-1	155,52	MM fiber	62,5 um	SDH	SC	LAN/WAN
SDH STM-4	622,08	SM fiber		NRZ	SC (ST)	LAN
SDH STM-4	622,08	MM (LED)		NRZ	SC (ST)	LAN
SDH STM-4	622,08	MM (Laser)		NRZ	SC (ST)	LAN
SDH STM-1	155,52	UTP5	100 Ohm	NRZI	RJ45	LAN
SDH STM1	155,52	STP (Type1)	150 Ohm	NRZI	9pinD	LAN
Fiber Channel	155,52	MM fiber	62,5 um	8B/10B		LAN
TAXI	100	MM Fiber	62,5 um	4B/5B	MIC	LAN
SONET STS1	51,84	UTP3		NRZI	RJ45	LAN
ATM25	25,6	UTP3		NRZI	RJ45	LAN

© 2007, D.I. Manfred Lindner

ATM Technology, v4.2

41

Agenda

- Introduction
- ATM Reference Model
- Physical Layer
- ATM Layer
- ATM Switching Details
- ATM Adaptation Layer
- ATM Signaling and Addressing

© 2007, D.I. Manfred Lindner

ATM Technology, v4.2

42

Appendix 5 - ATM Technology in Detail

ATM Layer

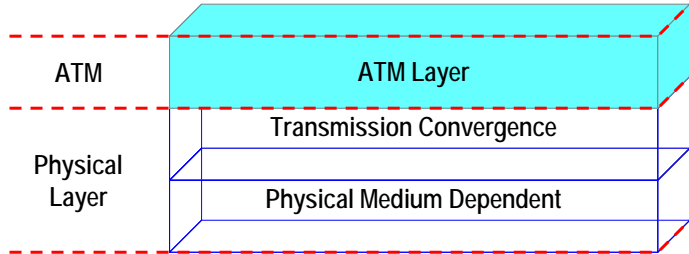

- **Transparent transfer of ATM cells**
 - Independent of Physical Layer
- **Multiplexing/demultiplexing of cells with different VCI/VPI**
- **Translation of VPI/VCI (label swapping)**

© 2007, D.I. Manfred Lindner ATM Technology, v4.2 43

ATM Layer

- **Extraction/addition of cell header at destination/source**
- **Switching of cells with Label Swapping**
- **Error management - OAM cells (F4/F5)**
 - OAM = Operation And Maintenance
- **Meta signaling**
- **QoS negotiation and control**
- **Traffic shaping**
 - Ensures that nodes do not exceed their committed QoS parameters
- **Flow control (in case of ABR)**

© 2007, D.I. Manfred Lindner ATM Technology, v4.2 44

Appendix 5 - ATM Technology in Detail

Cell Format

8	7	6	5	4	3	2	1	
GFC		VPI						1
VPI		VCI						2
VCI								3
VCI		PT	CLP					4
HEC								5

UNI Header

8	7	6	5	4	3	2	1	
VPI				VPI				1
VPI				VCI				2
VCI								3
VCI		PT	CLP					4
HEC								5

NNI Header

- **Two slightly different formats**
 - UNI ... 8 bits for VPI
 - NNI ... 12 bits for VPI

© 2007, D.I. Manfred Lindner ATM Technology, v4.2 45

Cell Format

- **Cell Size**
 - 53 byte
 - 5 byte header and 48 byte payload
- **Generic Flow Control (GFC)**
 - Not contained in the NNI header -> not transported through the network
 - Local significance between ATM endpoint and switch
 - Not used!
 - Today, special flow-control cells are used instead

© 2007, D.I. Manfred Lindner ATM Technology, v4.2 46

Appendix 5 - ATM Technology in Detail

Cell Format

• VPI and VCI

- VPI - Virtual Path Identifier
- VCI - Virtual Channel Identifier
- VPI/VCI identifies the virtual connection
 - Similar function as the X.25 logical channel identifier or the Frame Relay DLCI
- Reserved values used for
 - Signaling
 - Operation and maintenance
 - Resource management
- Idle cells - VPI/VCI set to "0"
 - Used within framed structures like SDH and PDH
 - Not needed within unframed structures like TAXI
 - User data is 0x55 pattern (0101 0101)

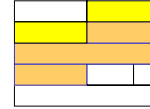

© 2007, D.I. Manfred Lindner

ATM Technology, v4.2

47

Reserved VPI/VCI Values

VPI	VCI	Function
0	0- 15	ITU-T
0	16 - 31	ATM Forum
0	0	Idle Cell
0	3	Segment OAM Cell (F4)
0	4	End-to-End OAM Cell (F4)
0	5	Signaling
0	16	ILMI
0	17	LANE
0	18	PNNI

© 2007, D.I. Manfred Lindner

ATM Technology, v4.2

48

Appendix 5 - ATM Technology in Detail

Cell Format

- Payload Type (3 bits)**
 - Used by AAL5 to flag end of block
 - Used to signal congestion

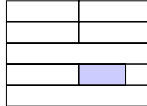

User data/OAM
0 - user data

0/1 0/1 0/1

Congestion Bit 1 if congested
(EFCI Explicit Forward Congestion Indication)

User Signaling Bit
(AAL5 EOM)

Value	OAM Type
100	OAM link associated cell
101	OAM end-to-end cell
110	Resource management cell
111	Reserved

(OAM = Operation, Admin, Management)
RM cell (Flow control in ABR)

© 2007, D.I. Manfred Lindner ATM Technology, v4.2 49

Cell Format

- Cell Loss Priority (CLP)**
 - Similar to the DE-bit in Frame Relay
 - Normal transmission: CLP = 0
 - Low priority, might be discarded: CLP = 1
- Header Error Check (HEC)**
 - Allows the correction of single-bit errors in the cell header or
 - Allows the detection of most multi-bit errors
 - Also used for determining cell boundaries on some types of physical link connection
 - ITU-T standard I 4.321
 - Switch must find 6 successive hits at any time

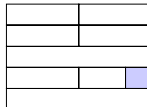
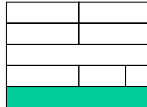
© 2007, D.I. Manfred Lindner ATM Technology, v4.2 50

Appendix 5 - ATM Technology in Detail

Agenda

- Introduction
- ATM Reference Model
- Physical Layer
- ATM Layer
- ATM Switching Details
- ATM Adaptation Layer
- ATM Signaling and Addressing

Switching Principles

- **Each virtual connection is represented by two IDs**
 - Virtual Path Identifier (VPI)
 - Virtual Channel Identifier (VCI)
- **Switching is done by using table pointers**
 - Table of VPIs relating to each physical link
 - Table of VCIs for each terminating VP
- **VP switch**
 - Only changes the VPI of a cell, used for VC aggregation on intermediate switch(es)
- **VC switch**
 - Changes the VPI and VCI

Appendix 5 - ATM Technology in Detail

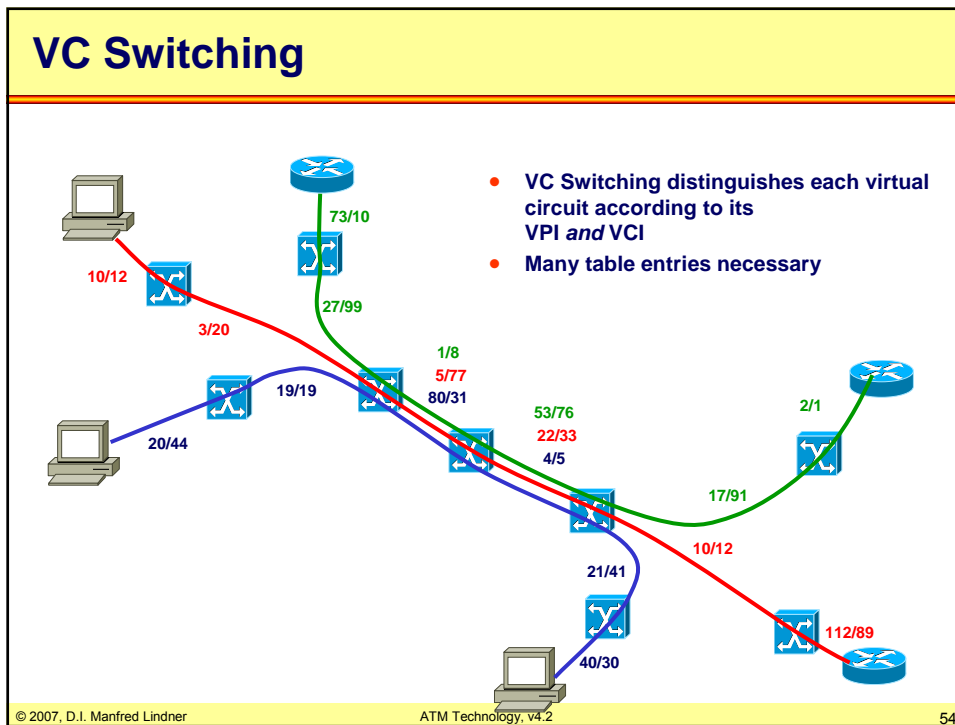
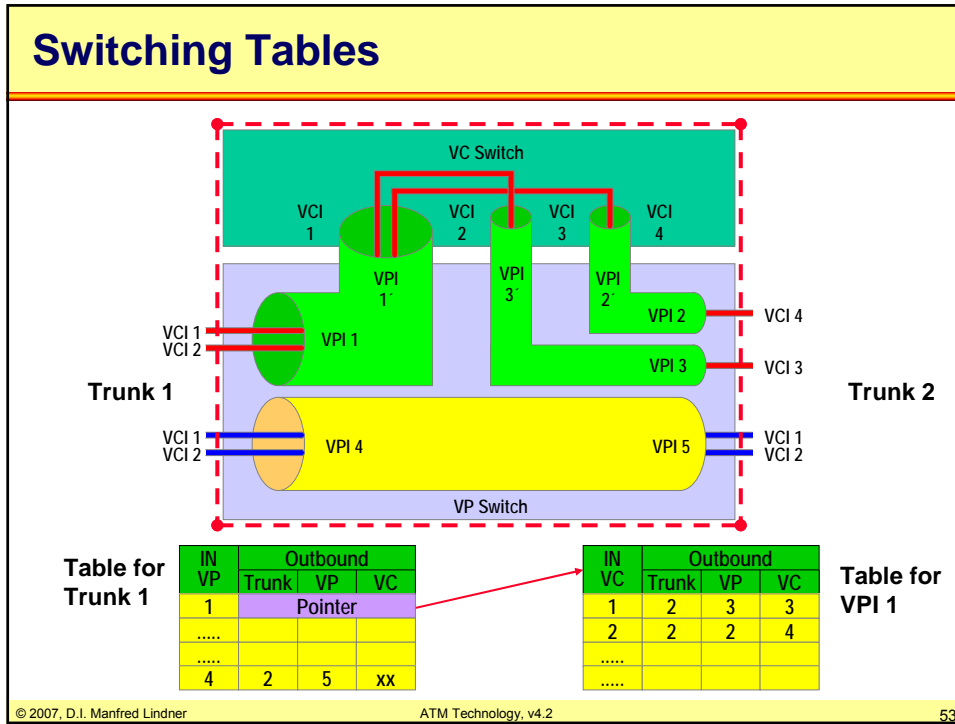

Appendix 5 - ATM Technology in Detail

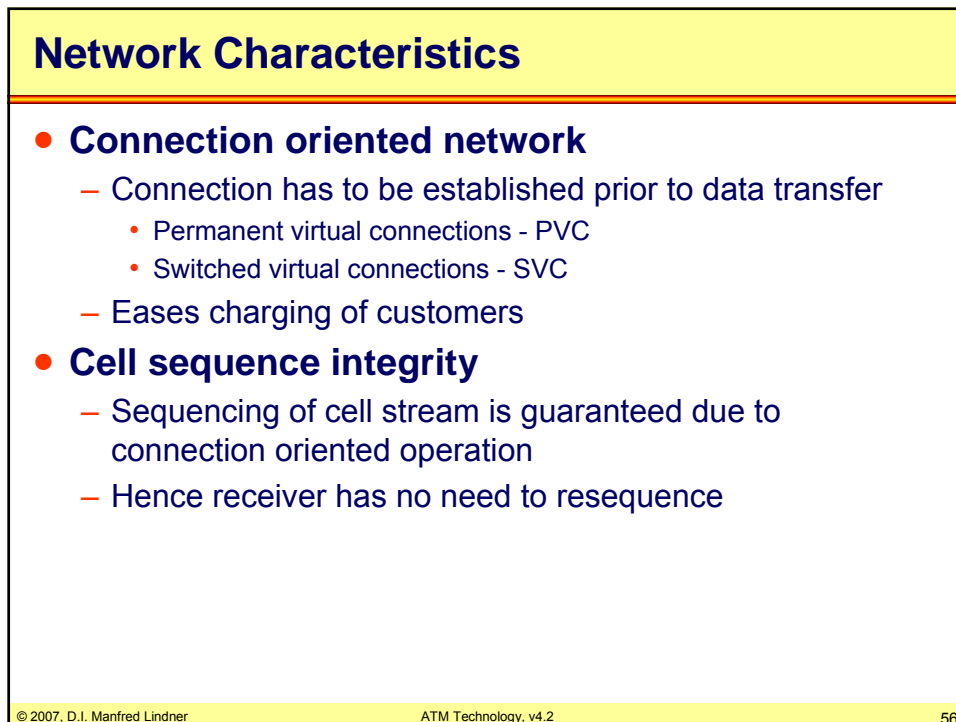
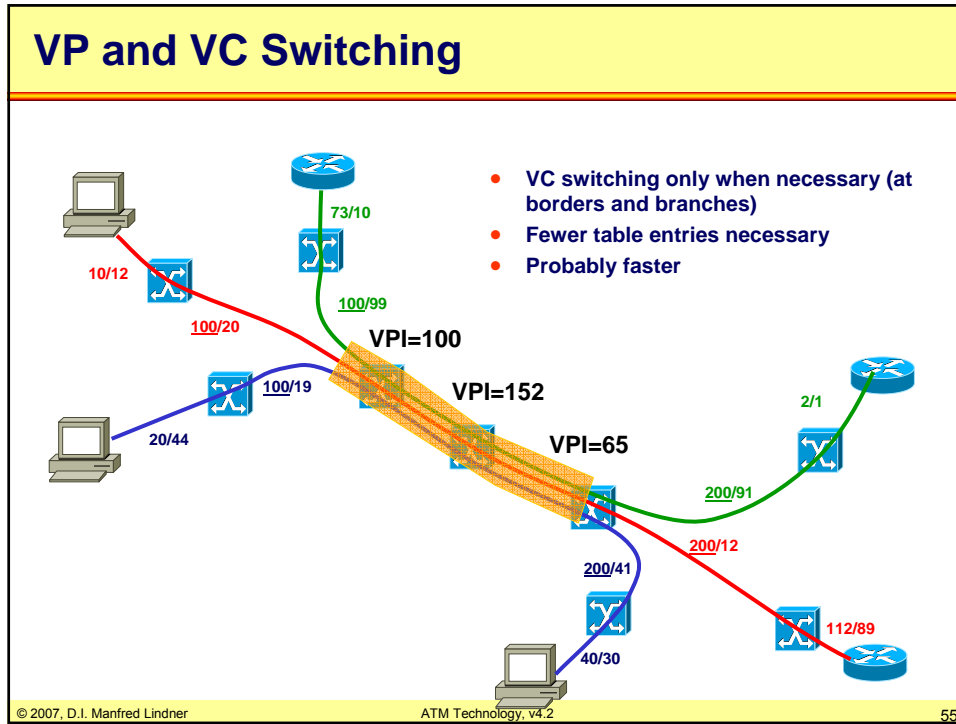

Appendix 5 - ATM Technology in Detail

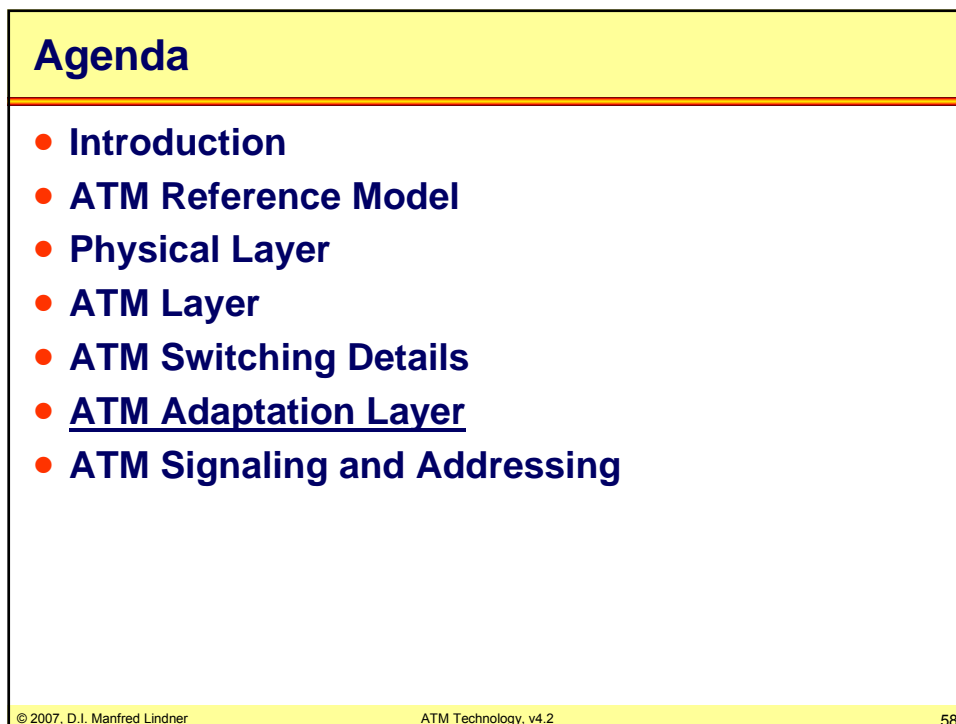
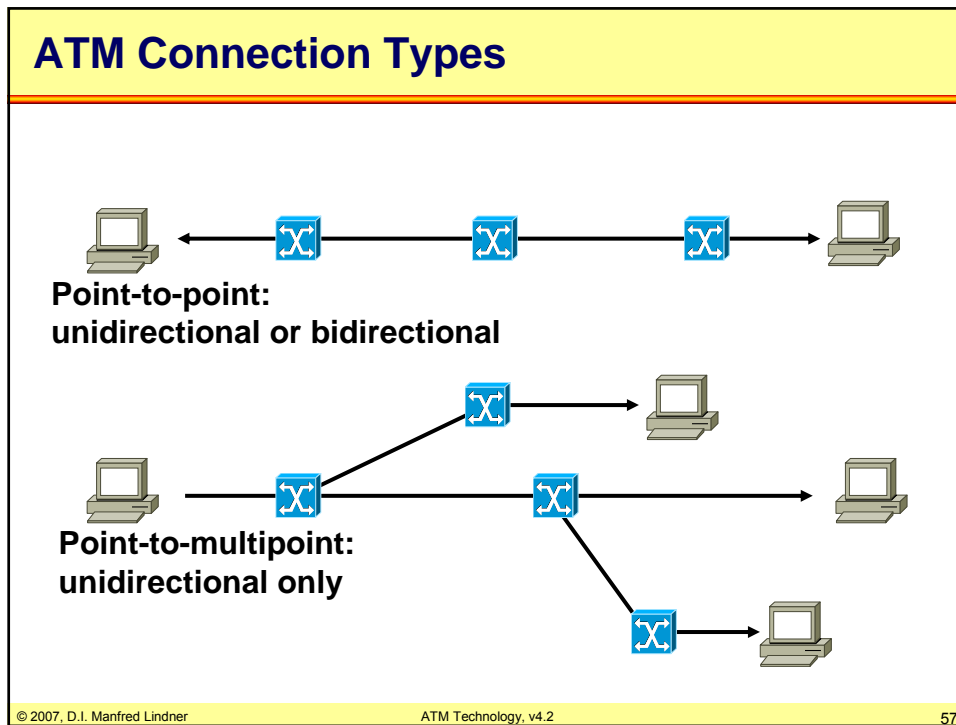

Appendix 5 - ATM Technology in Detail

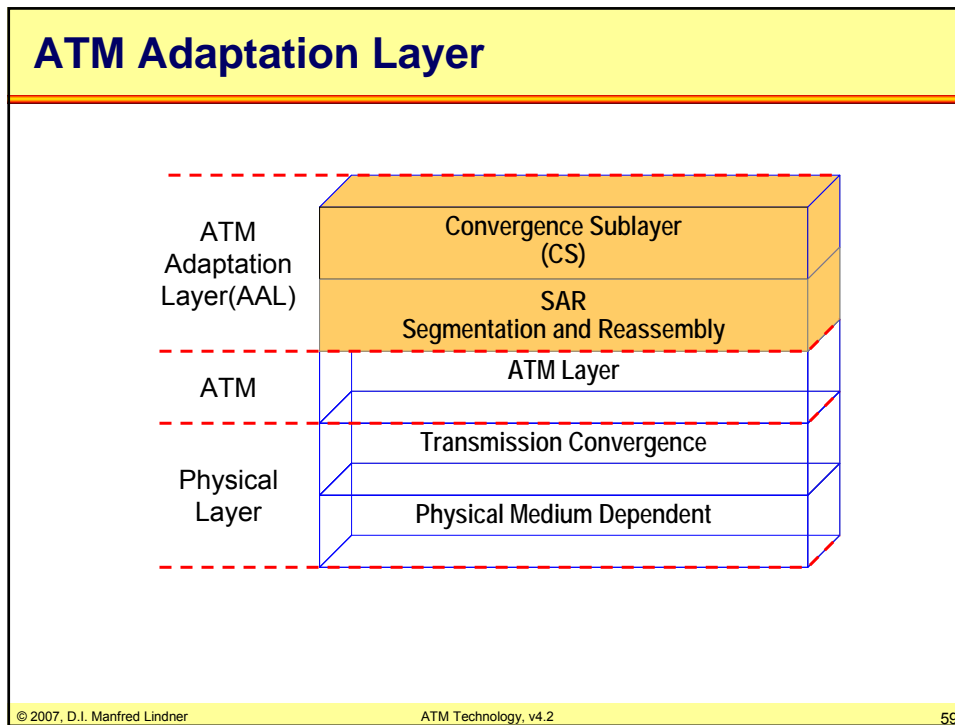

Adaptation Layers

- **ATM only provides bearer service**
- **ATM cannot be used directly**
- **Applications must use **adaptation layers** to access the ATM layer**
- **Adapts different kind of information streams to ATM**
 - Constant Bit Rate (CBR), Variable Bit Rate (VBR)
 - Connection-oriented Data (CO-D), Connection-less Data (CL-D)
- **Consist of SAR and CS**
 - Part of ATM-end-systems (DTE's) only
 - Transparent for ATM-switches (DCE's)

© 2007, D.I. Manfred Lindner ATM Technology, v4.2 60

Appendix 5 - ATM Technology in Detail

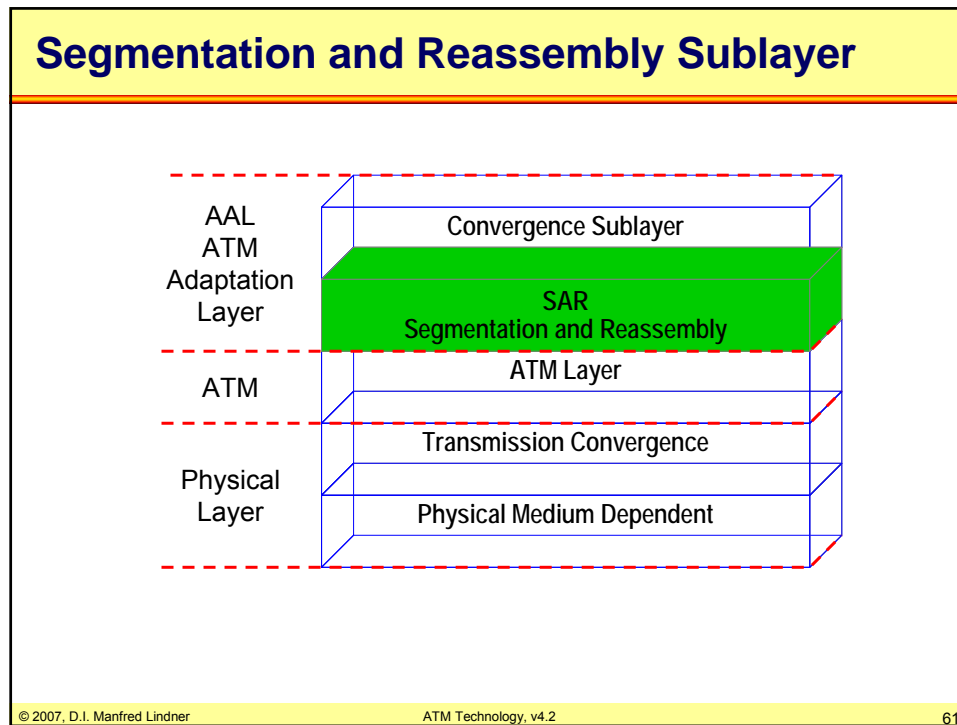

- ### SAR Layer
- **Segmentation and Reassembly Sublayer**
 - Used to “fill” information into ATM cell payload
 - Segmentation in and reassembly from ATM cells
- © 2007, D.I. Manfred Lindner ATM Technology, v4.2 62

Appendix 5 - ATM Technology in Detail

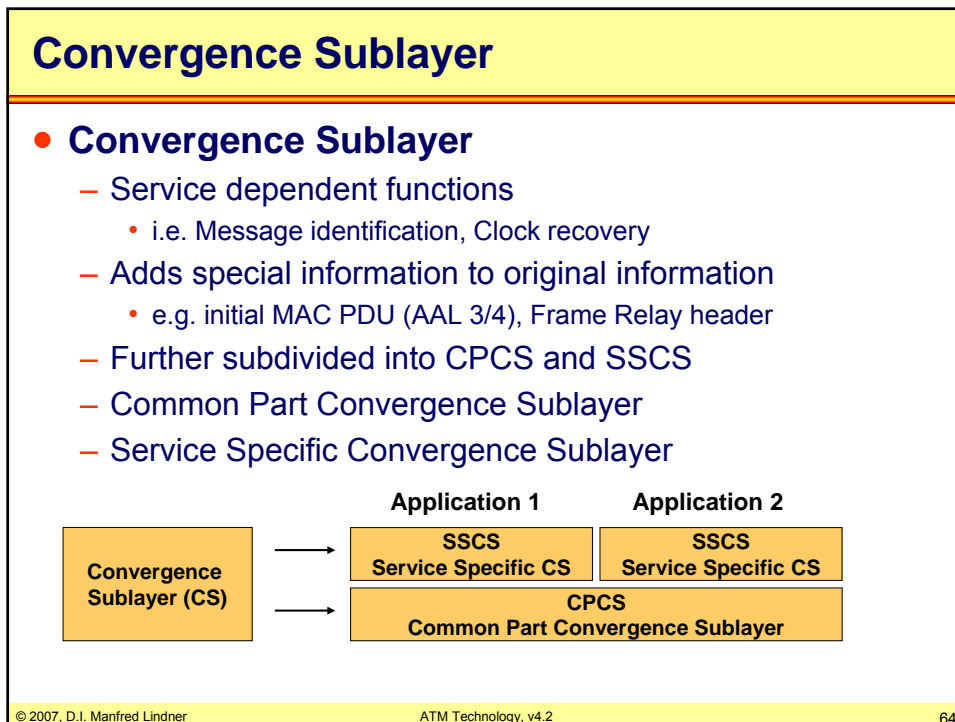
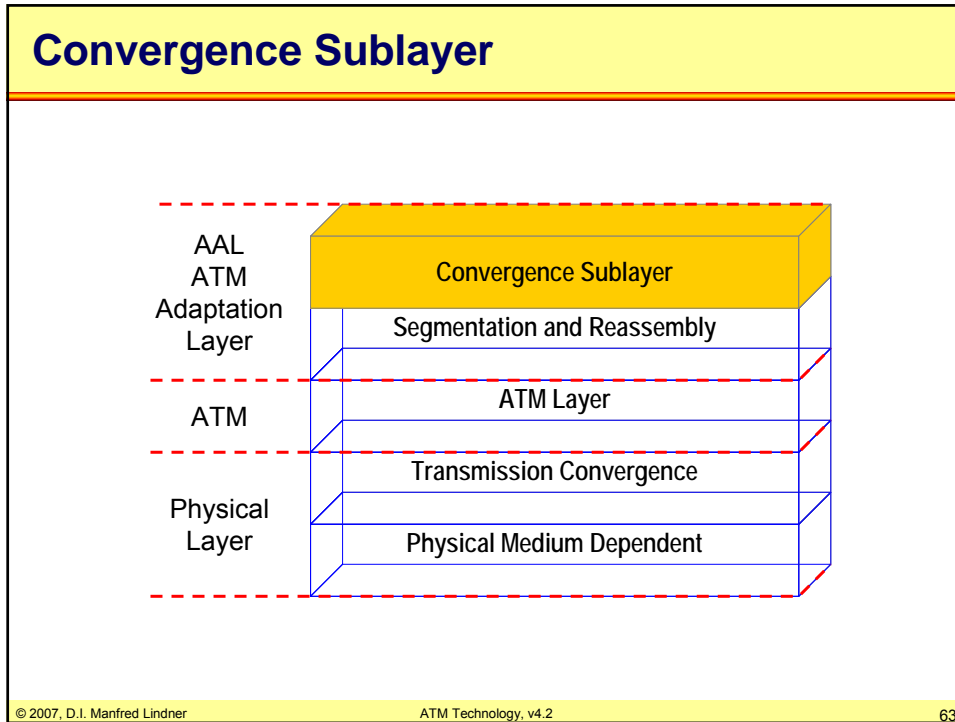

Appendix 5 - ATM Technology in Detail

Types of AAL

- **Service types and corresponding AAL's were defined for different traffic classes**

- Class A (CBR) e.g. Circuit Emulation of E1, T1 frame structures
- Class B (VBR) e.g. Packet Video, Packet Audio
- Class C (CO-D) e.g. Frame Relay, X.25
- Class D (CL-D) e.g. IP, SMDS

	Class A	Class B	Class C	Class D
Synchronization between Source and Destination	required	required	not required	not required
Bit rate	constant	variable	variable	variable
Connection Type	conn. oriented	conn. oriented	conn. oriented	conn. less
Adaptation Layer	AAL 1	AAL 2	AAL 3 or AAL5	AAL 4 or AAL5

© 2007, D.I. Manfred Lindner

ATM Technology, v4.2

65

AAL1

- **Purpose**

- transfer service data units received from a source at constant rate and then deliver them at the same rate to the destination
- optionally transfer timing information between source and destination (SRTS ... Synchronous Residual Time Stamp)
- optionally transfer TDM structure information between source and destination (e.g. timeslot 0 of E1)

- **That is Circuit Emulation Service (CES)**

- **Constant Bit Rate (CBR) service**

- Expensive
 - Over provisioning like leased line necessary
 - Queuing prefers AAL1 cells over all other traffic (in case of congestion)

© 2007, D.I. Manfred Lindner

ATM Technology, v4.2

66

Appendix 5 - ATM Technology in Detail

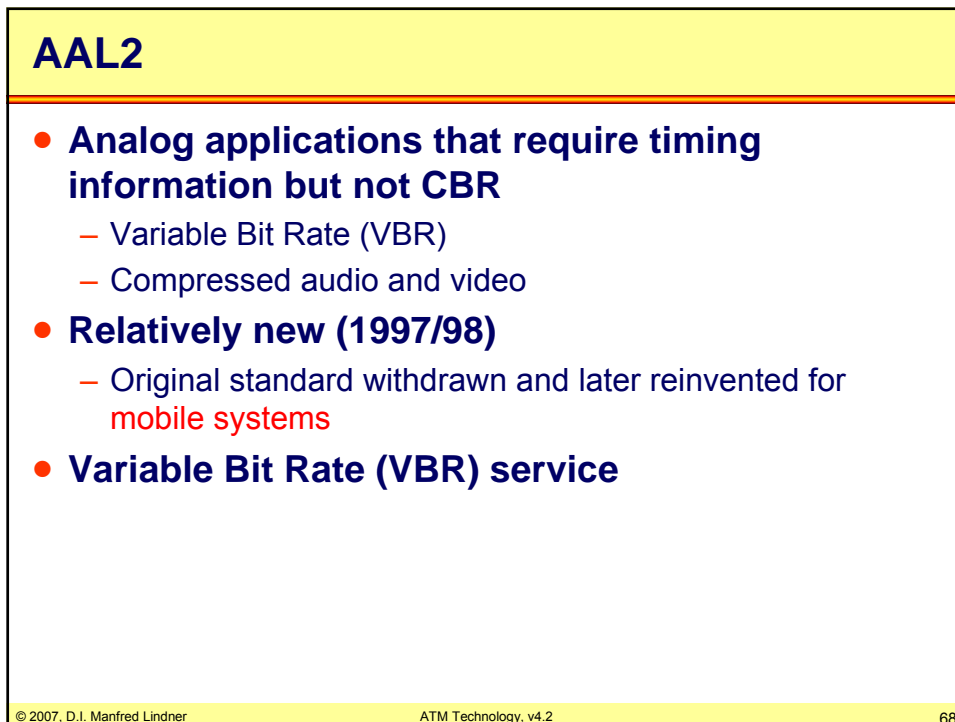
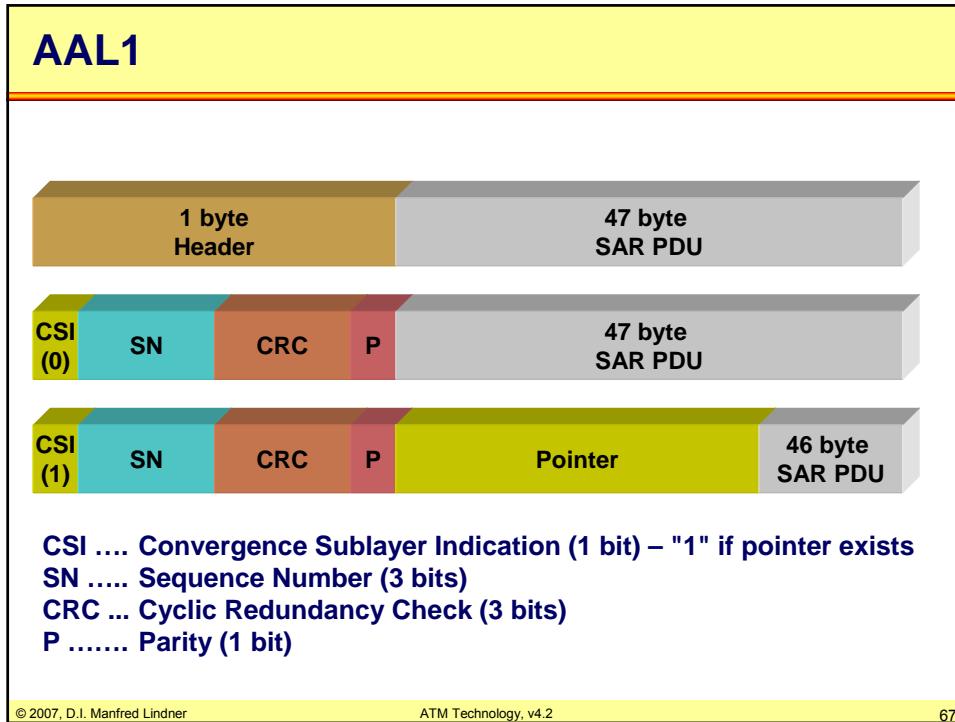

Appendix 5 - ATM Technology in Detail

AAL2 for Mobile Systems

- **Cellular communication issues**
 - Packetization delay (→ QoS)
 - Bandwidth efficiency (→ Money)
- **Before AAL2 low-bit rate real-time applications were used by "partial filling" of ATM cells**
 - Using "AAL0" or AAL1
 - Very inefficient (few bytes per cell only)
- **AAL2 is designed to be fast and efficient**

© 2007, D.I. Manfred Lindner

ATM Technology, v4.2

69

AAL2 – CS

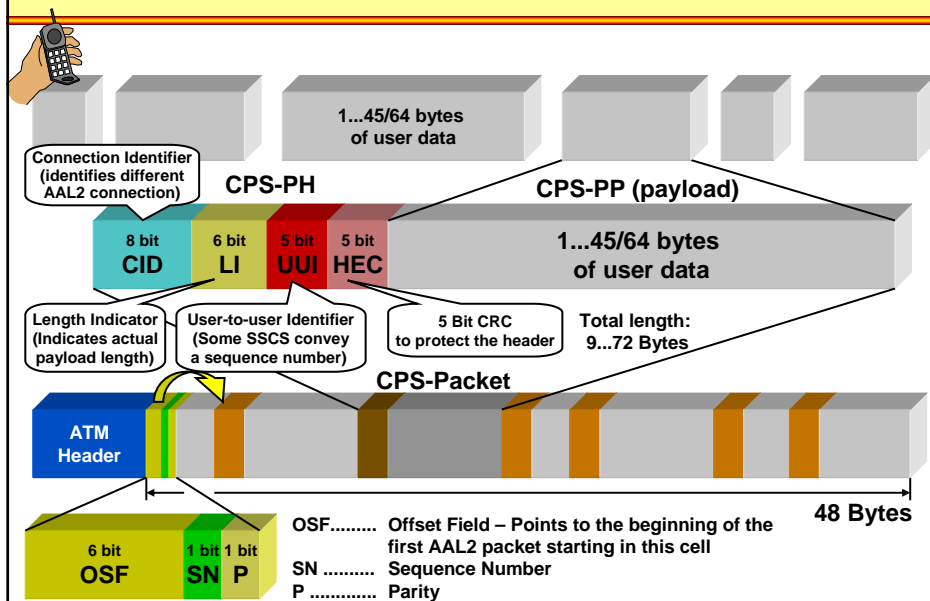

© 2007, D.I. Manfred Lindner

ATM Technology, v4.2

70

Appendix 5 - ATM Technology in Detail

AAL3 + AAL4

- **AAL3 designed to carry connection-oriented packets**
 - Such as X.25 or Frame Relay
- **AAL4 designed to carry connection-less datagram's**
 - Such as IP or IPX
- **Because of similarity both adaptation layers were combined to AAL3/4**

© 2007, D.I. Manfred Lindner

ATM Technology, v4.2

71

AAL3/4 – Step 1: CS

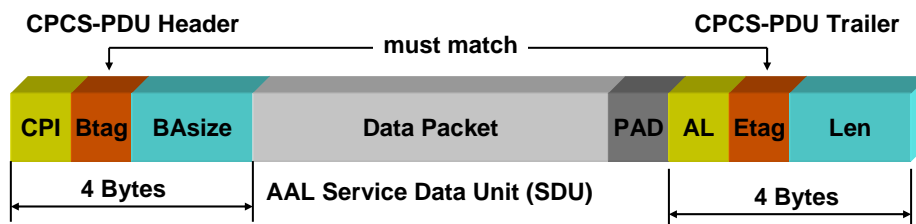

CPI Common Part Indicator (1Byte)
Btag..... Beginning tag (1 Byte)
BAsize... Buffer allocation size (2 Bytes)
PAD..... for 32 bit alignment
AL..... Alignment (1 Byte)
Etag..... Ending tag (1 Byte) – must match Btag
Len Length of SAR PDU

© 2007, D.I. Manfred Lindner

ATM Technology, v4.2

72

Appendix 5 - ATM Technology in Detail

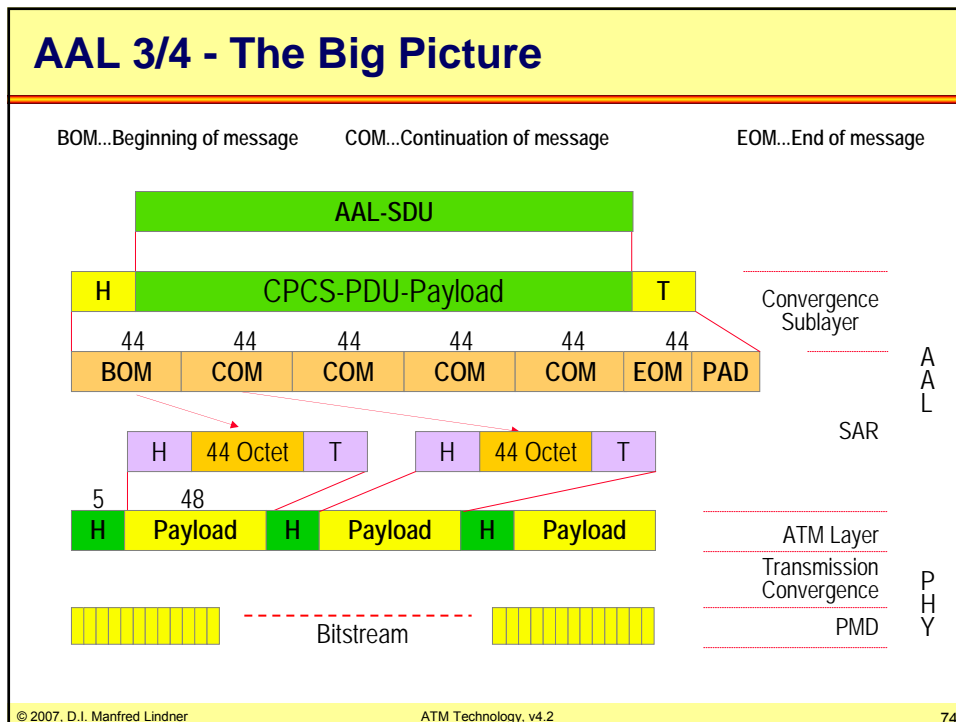
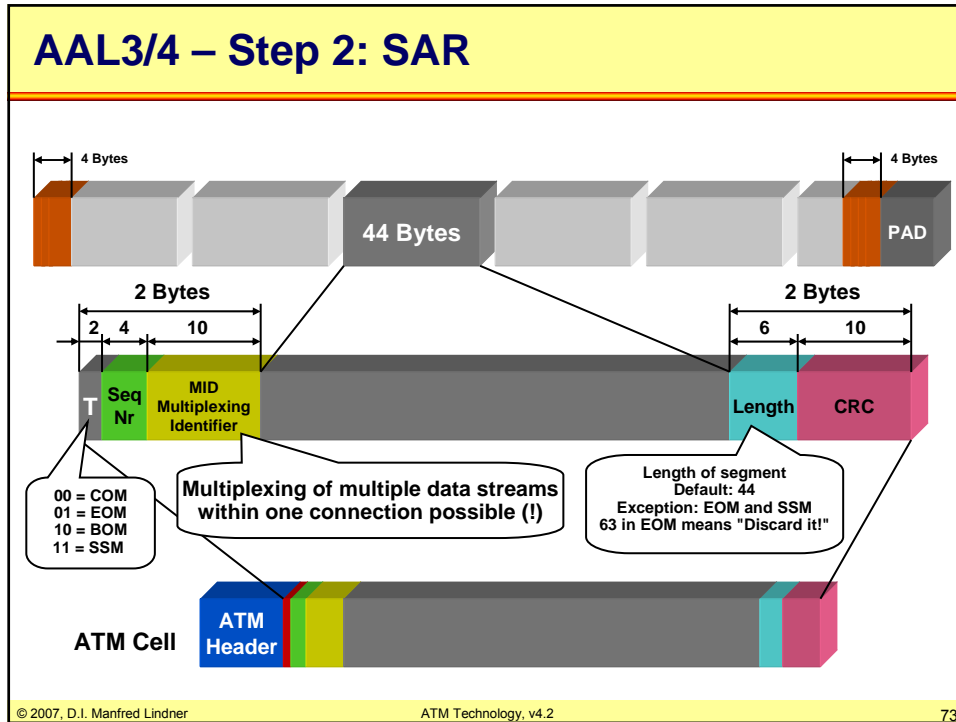

Appendix 5 - ATM Technology in Detail

AAL3/4

- **Can multiplex different streams of data on the same ATM connection**
 - Up to 210 streams using the same VPI/VCI
- **But too much overhead**
 - Sequence numbers unnecessary when not interleaving
 - One CRC for whole packet would be sufficient
 - Length unnecessary
 - Nearly totally replaced by AAL5

© 2007, D.I. Manfred Lindner

ATM Technology, v4.2

75

AAL5

- **Favorite for data communication**
 - AAL 5 simulates connectionless data interface
 - Packet AAL with less overhead than AAL 3/4
 - Minimizes computer costs in terms of handling cells
 - Behaves as far as possible like existing data communications interfaces
 - Allows simple migration to ATM
- **Smallest overhead**
 - Convergence Layer:
8 byte trailer in last cell
 - SAR Layer:
just marks EOM in ATM header (PT)

© 2007, D.I. Manfred Lindner

ATM Technology, v4.2

76

Appendix 5 - ATM Technology in Detail

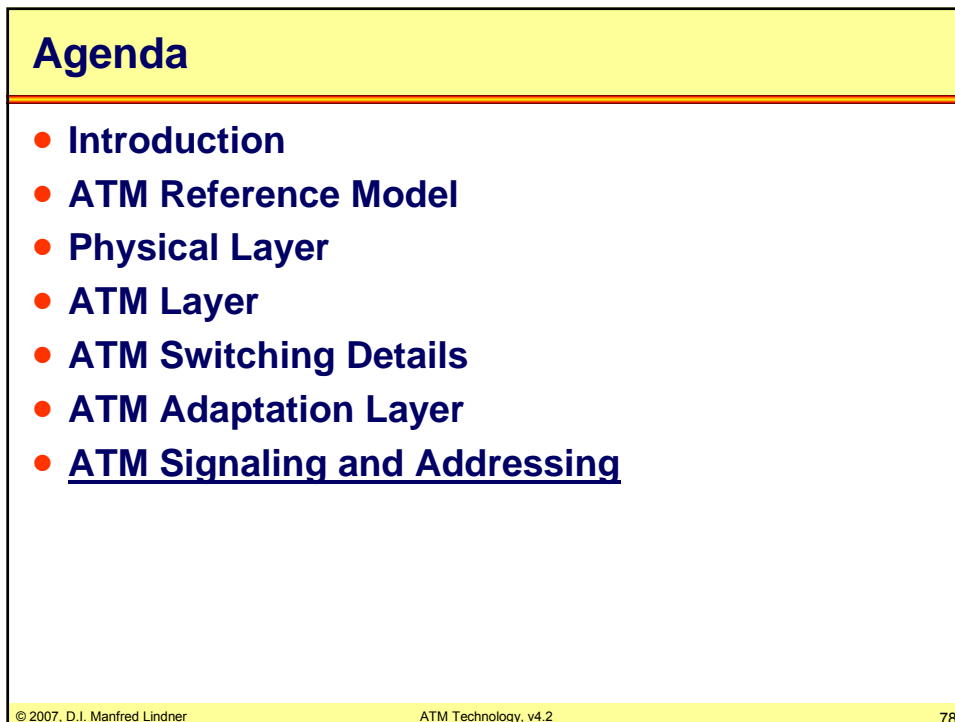
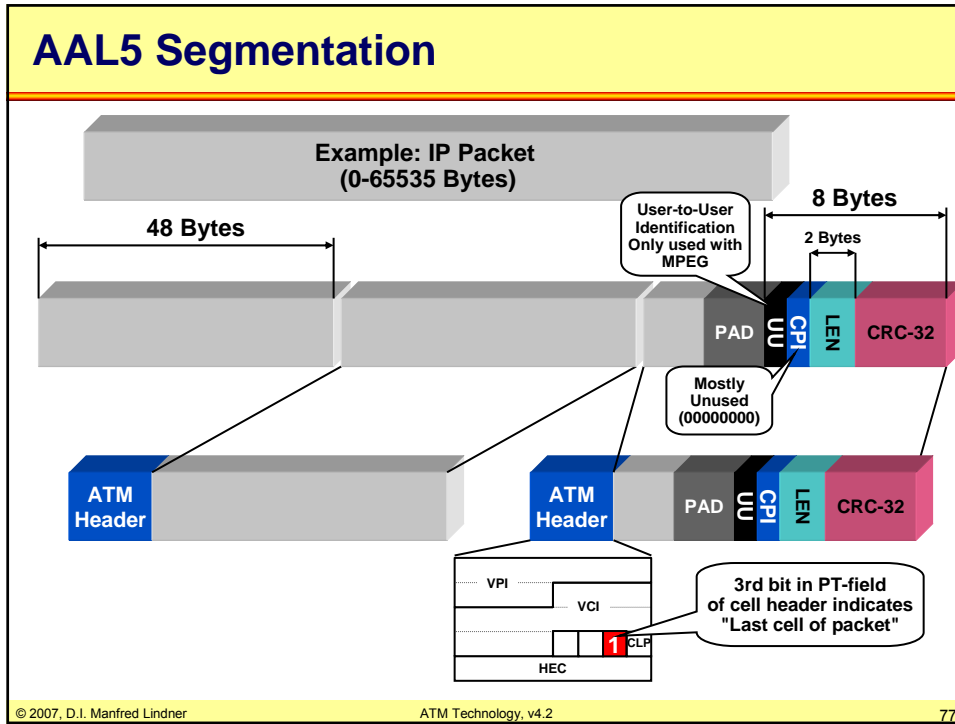

Appendix 5 - ATM Technology in Detail

Signaling

- **ATM is connection oriented**
- **Requires signaling to establish connections**
 - between ATM-DTE and ATM-DCE (UNI)
 - between ATM-DCE and ATM-DCE (NNI)
 - Special VPI/VCI values are used for that
- **ATM Forum UNI signaling specification**
 - UNI 3.0, 3.1 and 4.0 standardized
 - UNI 2.0 PVC
 - UNI 3.0 PVC+SVC, CBR+VBR+UBR
 - UNI 4.0 +ABR, QoS Negotiation
- **Based on ITU-T Q.2931 (B-ISDN)**

© 2007, D.I. Manfred Lindner

ATM Technology, v4.2

79

Signaling Layers

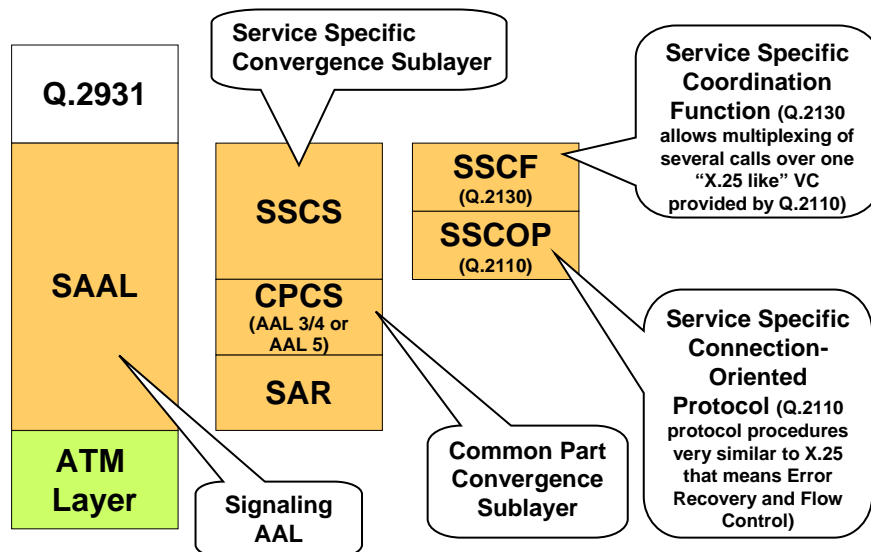

© 2007, D.I. Manfred Lindner

ATM Technology, v4.2

80

Appendix 5 - ATM Technology in Detail

Signaling Aspects

- **ITU-T**
 - Recommends AAL 3/4 for CPCS
- **ATM Forum**
 - Recommends AAL 5 for the CPCS
- **Q.2931 protocol**
 - Connection establishment
 - Negotiation of performance parameters
 - Derivate of Q.931 (N-ISDN) and Q.933 (UNI signaling protocol for Frame Relay)
 - VPI/VCI used instead of a D-channel (N-ISDN)
 - Uses meta signaling to establish signaling paths and channels (ITU-T)

© 2007, D.I. Manfred Lindner

ATM Technology, v4.2

81

VPI/VCI for ATM Signaling

- **Reserved UNI headers - ITU-T**
 - Meta signaling - VPI=0, VCI=1
 - Broadcast signaling - VPI=0, VCI=2
- **Reserved UNI headers - ATM Forum**
 - Meta signaling - VPI=0, VCI=1
 - Broadcast signaling - VPI=0, VCI=2
 - Point-to-point signaling - VPI=0, VCI=5
 - ILMI - VPI=0, VCI=16
 - PNNI - VPI=0, VCI=18

© 2007, D.I. Manfred Lindner

ATM Technology, v4.2

82

Appendix 5 - ATM Technology in Detail

Meta - Signaling

- **Major functions**
 - Signaling channel connection setup
 - Signaling channel connection control
 - Signaling channel connection release
- **Used for the negotiation of the required VPI/VCI combination**
 - Signaling of signaling

© 2007, D.I. Manfred Lindner

ATM Technology, v4.2

83

ATM Addresses

- **Different types of ATM addresses**
- **All have 20 byte length**
- **All consist of three main parts**
 - **Prefix** (Basically topology information)
 - **End System Identifier (ESI)**
 - NSAP **Selector** (Selects application)
- **ATM address is a structured**
 - note: structured means that it contains topology specific information

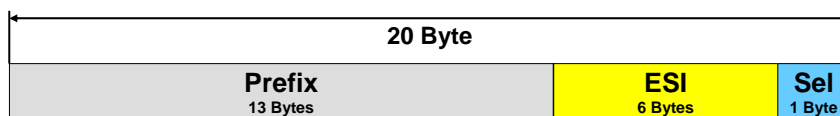

© 2007, D.I. Manfred Lindner

ATM Technology, v4.2

84

Appendix 5 - ATM Technology in Detail

ATM Addresses

- **ATM Forum defined three formats for ATM End System Address (ASEA)**
 - DCC ASEA format
 - ICD ASEA format
 - E.164 ASEA format
- **Private networks support ISO DCC and ICD formats**
- **Only public networks may use E.164 address format**
- **All formats**
 - are based on structured ISO Network Service Access Point (NSAP) addresses

© 2007, D.I. Manfred Lindner

ATM Technology, v4.2

85

ISO NSAP

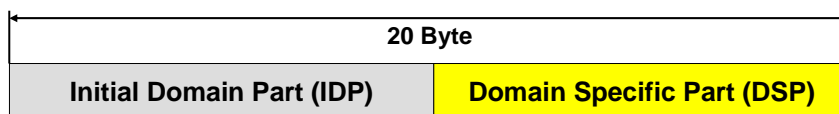

IDP ... identifies the network addressing authority responsible for assignment and allocation of the DSP

DSP ... is defined by the corresponding addressing authority and consists of

High Order DSP (HO-DSP)
for identifying networks on a prefix level

Low Order DSP (LO-DSP)
for identifying end systems

© 2007, D.I. Manfred Lindner

ATM Technology, v4.2

86

Appendix 5 - ATM Technology in Detail

