

L02 - Protocol Principles

Protocol Principles

Layering, CL versus CO Service, ARQ Techniques,
Sequence Numbers, Windowing, Flow Control

Agenda

- **Introduction**
 - 3 Layer Model and Service Types
- **ARQ Techniques**
 - Introduction
 - Idle RQ
 - Continuous RQ
 - Selective Acknowledgement
 - GoBackN
 - Positive Acknowledgement
 - Sequence Numbers and Windowing
 - Delay Bandwidth Product
 - Flow Control
 - HDLC Overview

L02 - Protocol Principles

Line Protocols

- **line protocols regulate and control communication between two devices over point-to-point line**
- **basic elements**
 - frame synchronization
 - frame protection
 - error detection
 - usually implemented in hardware
- **optional elements**
 - connection and line management
 - error recovery
 - flow control
 - usually implemented in software

© 2007, D.I. Manfred Lindner

Protocol Principles, v4.5

3

3 Layer Model

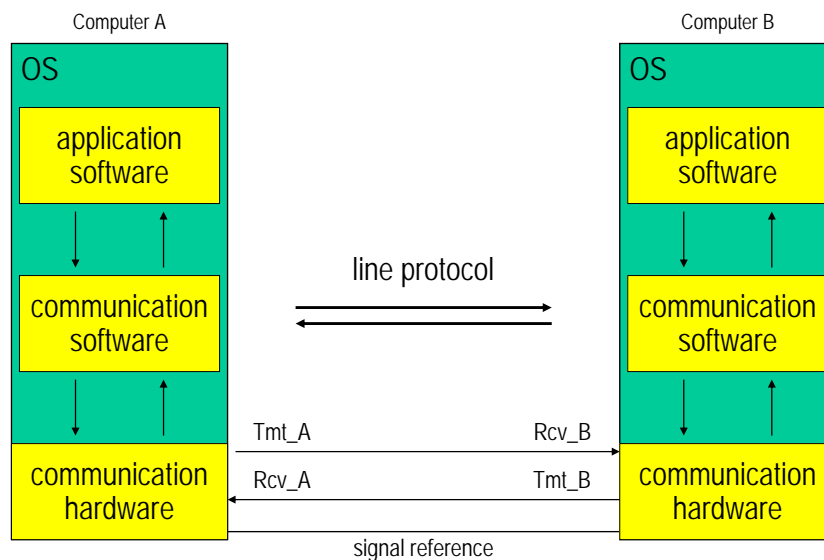

© 2007, D.I. Manfred Lindner

Protocol Principles, v4.5

4

L02 - Protocol Principles

Software Aspects

- **application software uses**
 - the communication software (normally part of an operating system , OS) in order to exchange data
- **mailbox and queueing techniques**
 - allow cooperation of application and communication software within a computer system
- **the communication software**
 - uses a line protocol for peer to peer communication
 - virtual communication relationship on a given layer
 - hides the details of line protocols and other related tasks from the application software
- **procedural approach**

© 2007, D.I. Manfred Lindner

Protocol Principles, v4.5

5

Cooperation of Software Layers

- **if information has to be transmitted from A to B**
 - the application SW of device A forwards some data blocks to the communication SW
 - the communication SW transmits the data using the communication hardware and the line protocol
 - the communication SW of device B receives the data and forwards it to the application SW
- **that means, the communication SW provides a service for the application SW**
 - this service can be connection-less or connection-oriented

© 2007, D.I. Manfred Lindner

Protocol Principles, v4.5

6

L02 - Protocol Principles

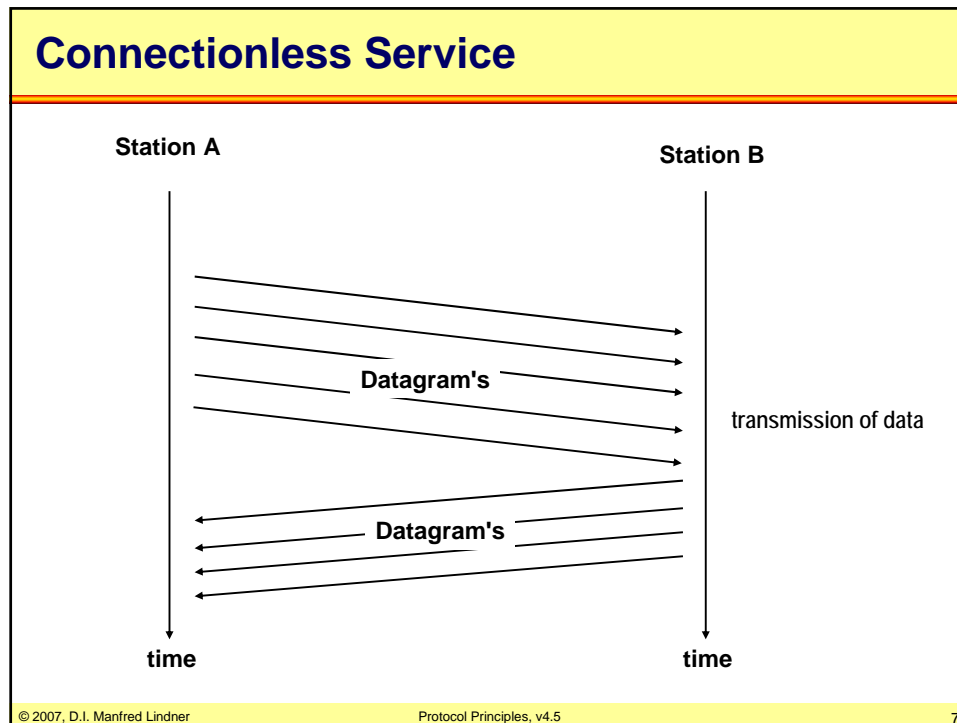

Line Protocol Services - CL

- **Connection-Less (CL) - type of service**
 - communication SW uses only basic elements (frame synchronization, frame protection, error detection) to transmit data blocks
 - transmission errors causes receiver to discard data blocks
 - best effort service
 - no special frame types are necessary to implement this protocol strategy
 - low implementation requirements for communication SW
 - but error recovery (correction of errors) must be done by application

© 2007, D.I. Manfred Lindner Protocol Principles, v4.5 8

L02 - Protocol Principles

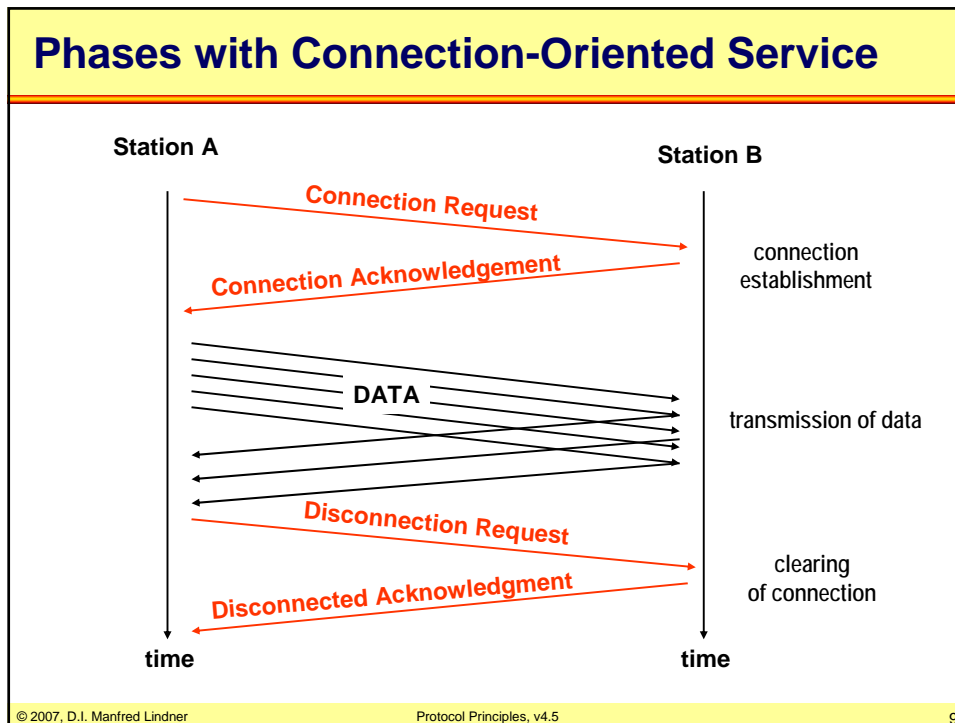

Line Protocol Services - CO

- **Connection-Oriented (CO) - type of service**
 - a communication channel must be established before data blocks can be transmitted
 - logical connection
 - transmission errors will be detected and corrected by the communication SW using feedback error control
 - retransmission of corrupted data blocks
 - **Automatic Repeat reQuest (ARQ) method**
 - reliable transmission service for application SW
 - error recovery done by communication SW
 - special frame types are necessary (connect, disconnect)
 - more sophisticated communication SW is necessary in order to implement ARQ strategy

L02 - Protocol Principles

Agenda

- **Introduction**
 - 3 Layer Model and Service Types
- **ARQ Techniques**
 - Introduction
 - Idle RQ
 - Continuous RQ
 - Selective Acknowledgement
 - GoBackN
 - Positive Acknowledgement
 - Sequence Numbers and Windowing
 - Delay Bandwidth Product
 - Flow Control
 - HDLC Overview

© 2007, D.I. Manfred Lindner

Protocol Principles, v4.5

11

Automatic Repeat Request (ARQ)

- **correct receipt of each transmitted data frame is acknowledged by the receiver**
 - special control message (ACK) in opposite direction
- **each data frame transmitted is stored in a retransmission buffer until receipt of corresponding acknowledgement**
- **if acknowledgement is not received, data frame will be retransmitted after a timeout**
- **identifiers (N, N+1, ...) are necessary to mark the sequence of data frames and to recognize duplicate frames**

© 2007, D.I. Manfred Lindner

Protocol Principles, v4.5

12

L02 - Protocol Principles

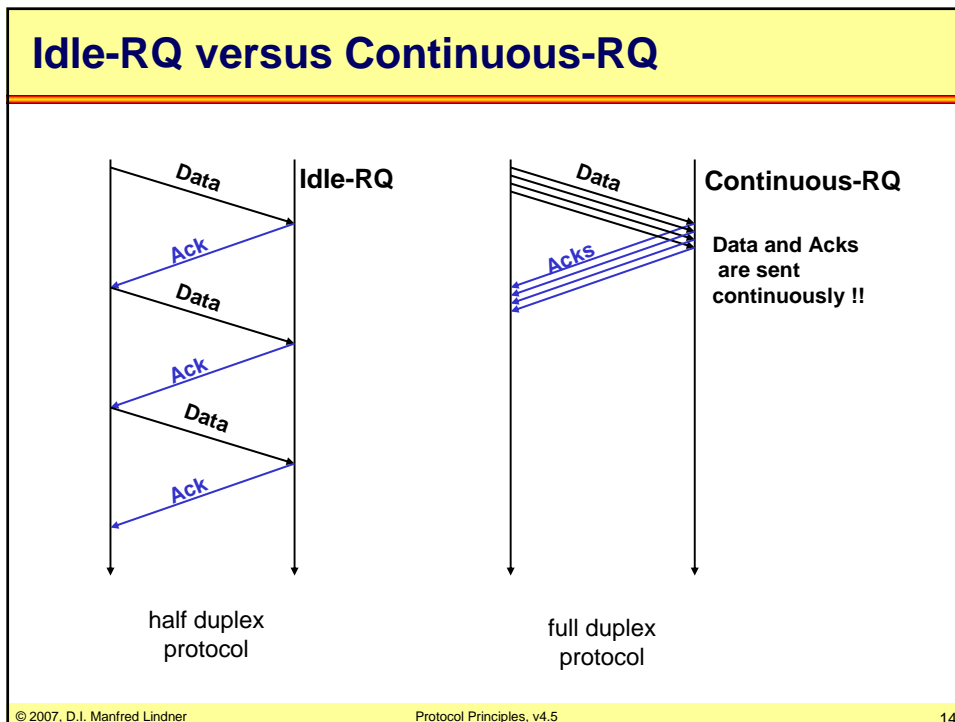
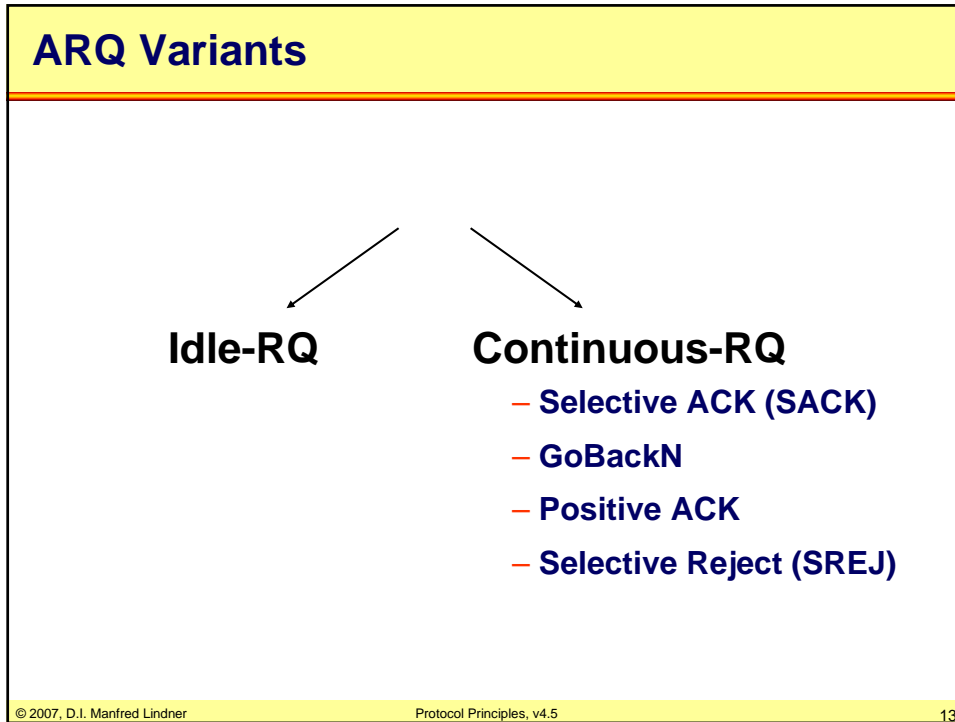

L02 - Protocol Principles

Idle-RQ and Continuous-RQ Facts

- **Idle-RQ**

- old and slow method
 - but small code and only little resources necessary
 - even today used e.g. TFTP (Trivial File Transfer Protocol)
- half duplex protocol

- **Continuous-RQ**

- requires *dramatically* more resources than Idle-RQ or connectionless protocols !!!
 - Retransmission Timers
 - Retransmission Buffers
 - Receive Buffers
- might result in high CPU loads !!!
- full duplex protocol

© 2007, D.I. Manfred Lindner

Protocol Principles, v4.5

15

Agenda

- **Introduction**

- 3 Layer Model and Service Types

- **ARQ Techniques**

- Introduction
- Idle RQ
- Continuous RQ
 - Selective Acknowledgement
 - GoBackN
 - Positive Acknowledgement
- Sequence Numbers and Windowing
- Delay Bandwidth Product
- Flow Control
- HDLC Overview

© 2007, D.I. Manfred Lindner

Protocol Principles, v4.5

16

L02 - Protocol Principles

Idle-RQ

- **simple ARQ implementation**
 - stop & wait protocol
 - device waits for the acknowledgement (ACK) before sending the next data frame
 - basic method can be improved by NACK
- **two identifiers are necessary (0, 1)**
 - distinction between new data frame or duplicate frame
- **numbering of data frames**
 - modulo 2
- **half duplex protocol**
- **full duplex lines can not be efficiently used**

© 2007, D.I. Manfred Lindner

Protocol Principles, v4.5

17

Basic Sequence of Idle-RQ

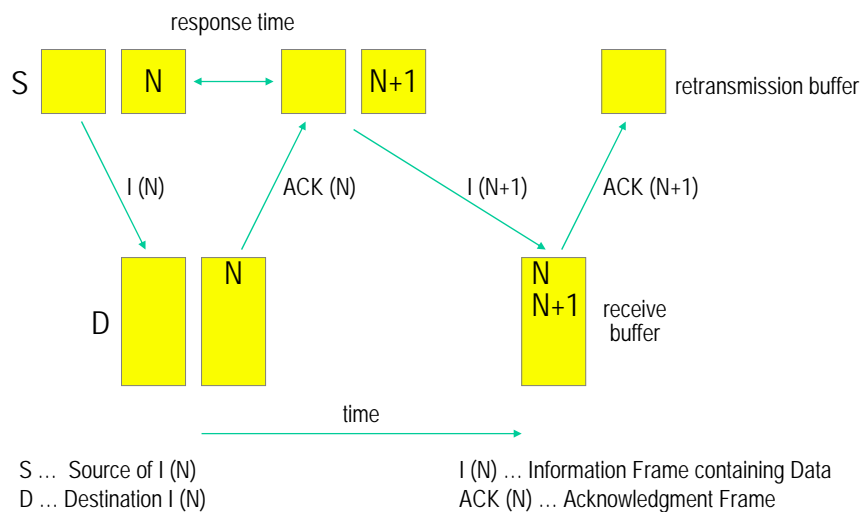

© 2007, D.I. Manfred Lindner

Protocol Principles, v4.5

18

L02 - Protocol Principles

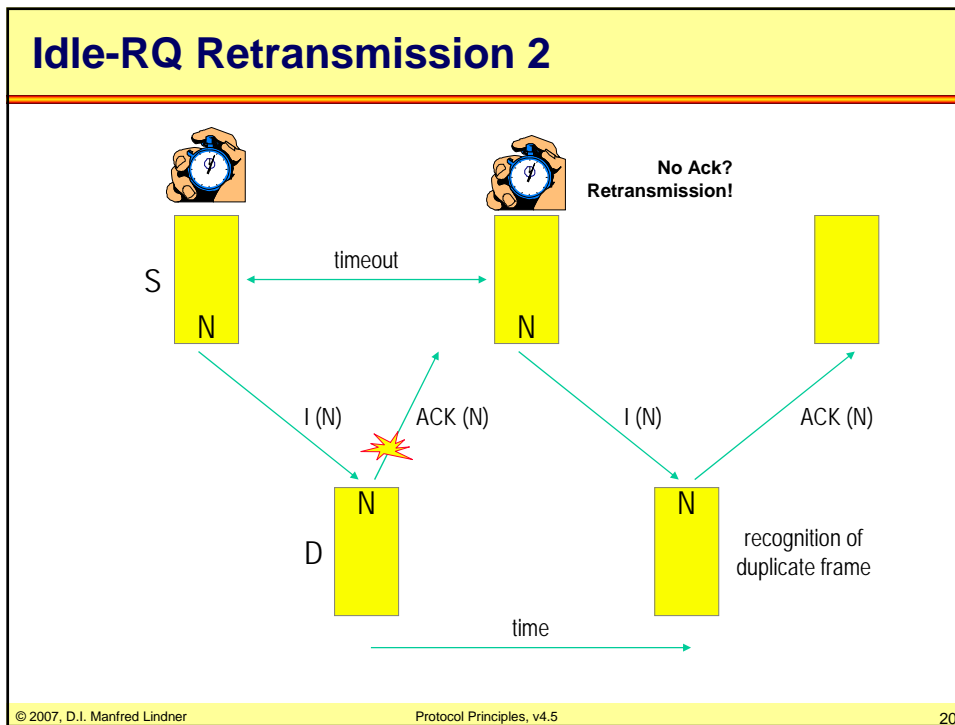
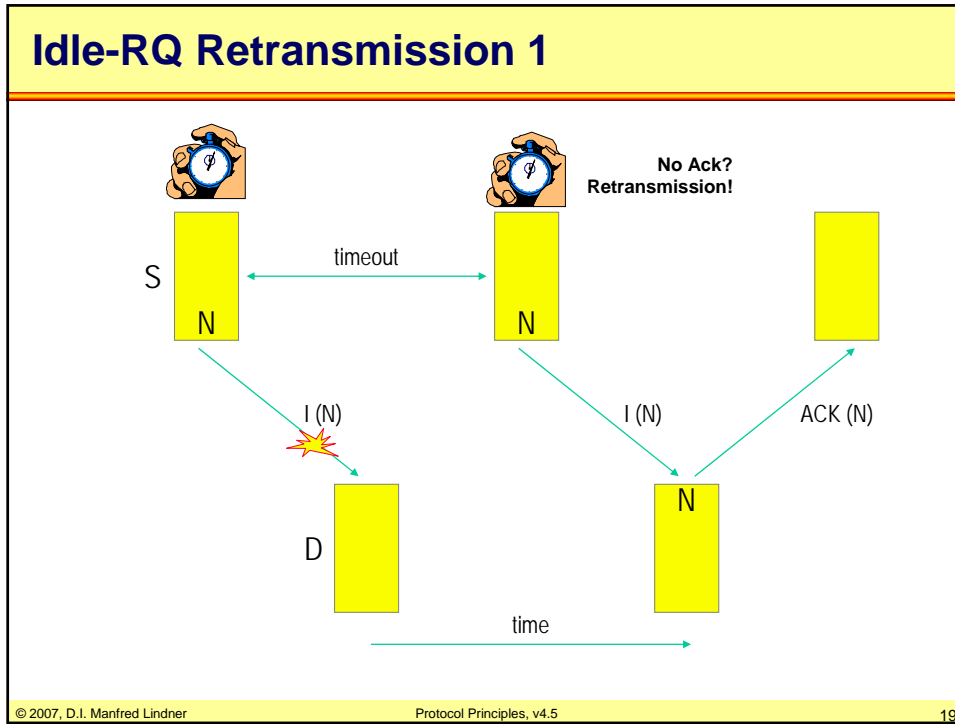

L02 - Protocol Principles

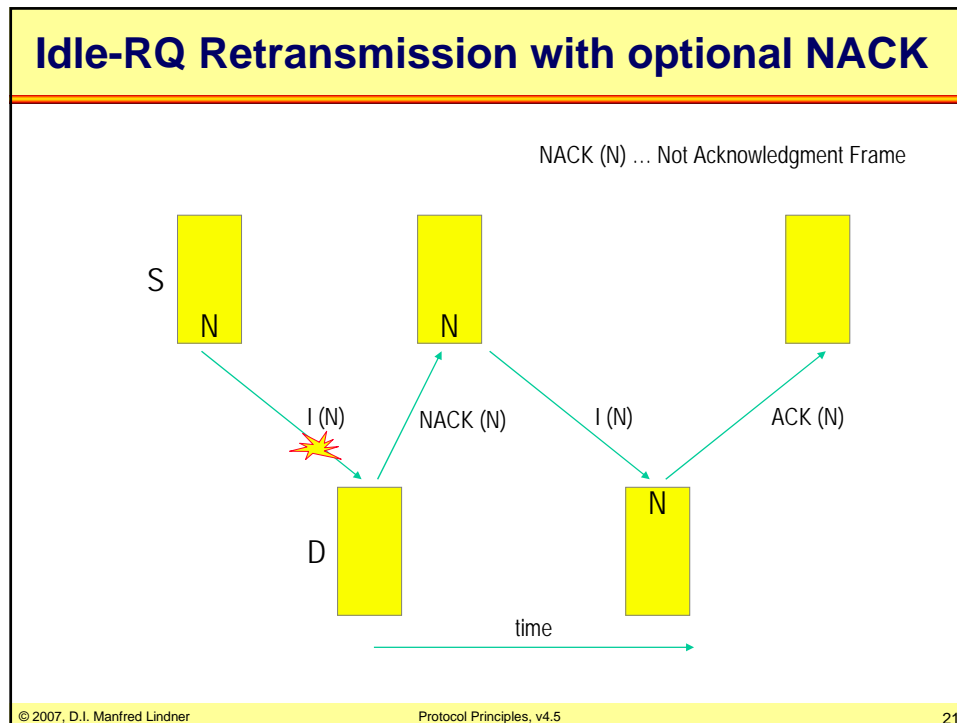

Agenda

- **Introduction**
 - 3 Layer Model and Service Types
- **ARQ Techniques**
 - Introduction
 - Idle RQ
 - Continuous RQ
 - Selective Acknowledgement
 - GoBackN
 - Positive Acknowledgement
 - Sequence Numbers and Windowing
 - Delay Bandwidth Product
 - Flow Control
 - HDLC Overview

© 2007, D.I. Manfred Lindner Protocol Principles, v4.5 22

L02 - Protocol Principles

Continuous-RQ

- in order to use full duplex lines more efficiently, device does not wait for acknowledgements for frames already sent
 - Continuous Repeat reQuest (C-RQ) protocols
- full duplex protocol
- until receipt of acknowledgments, data frames are buffered in a retransmission list
- each incoming acknowledgment removes the corresponding data frame from that list
- receiver stores data frames in receive list
 - to detect duplicates
 - to reorder the sequence

© 2007, D.I. Manfred Lindner

Protocol Principles, v4.5

23

Sequence of Continuous-RQ

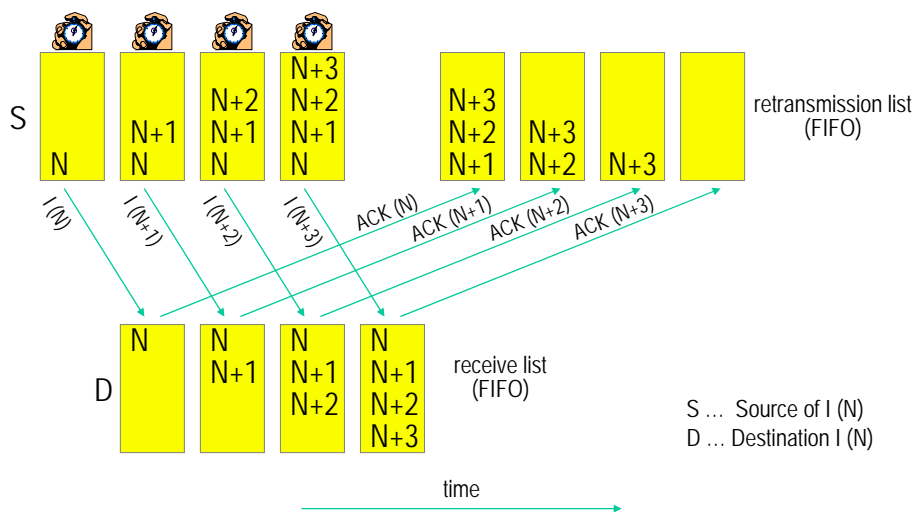

© 2007, D.I. Manfred Lindner

Protocol Principles, v4.5

24

L02 - Protocol Principles

Error Control Variants with Continuous-RQ

- **several methods for error control**
 - based on selective acknowledgement
 - selective retransmission done implicitly
 - order of frames is not maintained by the procedure
 - e.g. TCP (Transmission Control Protocol) SACK option
 - based on multiple and negative acknowledgement
 - also known as GoBackN
 - order of frames is maintained by the procedure
 - e.g. HDLC (High Level Data Link Control) check pointing technique and REJ option
 - e.g. DDCMP (Digital Data Link Control Management Protocol)

Error Control Variants with Continuous-RQ

- **several methods for error control (cont.)**
 - based on timeout and positive acknowledgement
 - order of frames is not maintained by the procedure
 - e.g. TCP's original procedure (early TCP)
 - note: today's TCP uses additionally duplicate ACK's to signal the rate of frames leaving the network to the sender
 - based on selective reject
 - selective retransmission done explicitly
 - order of frames is not maintained by the procedure
 - e.g. HDLC's SREJ option

L02 - Protocol Principles

Agenda

- **Introduction**
 - 3 Layer Model and Service Types
- **ARQ Techniques**
 - Introduction
 - Idle RQ
 - Continuous RQ
 - Selective Acknowledgement
 - GoBackN
 - Positive Acknowledgement
 - Sequence Numbers and Windowing
 - Delay Bandwidth Product
 - Flow Control
 - HDLC Overview

© 2007, D.I. Manfred Lindner

Protocol Principles, v4.5

27

Selective Acknowledgement

- **principle**
 - every data frame is exclusively confirmed
 - if acknowledgment is not received, corresponding data frame will be sent again and stored at the end of the retransmission list
 - in case of retransmission
 - data frames may not remain in sequence (scenario 1)
 - receiver must recognize duplicate frames and discard them (scenario 2)
 - each transmitted data frame starts an individual timer
 - which will be reset, if acknowledgement is received
 - if timeout occurs data frame is sent once again (scenario 3)

© 2007, D.I. Manfred Lindner

Protocol Principles, v4.5

28

L02 - Protocol Principles

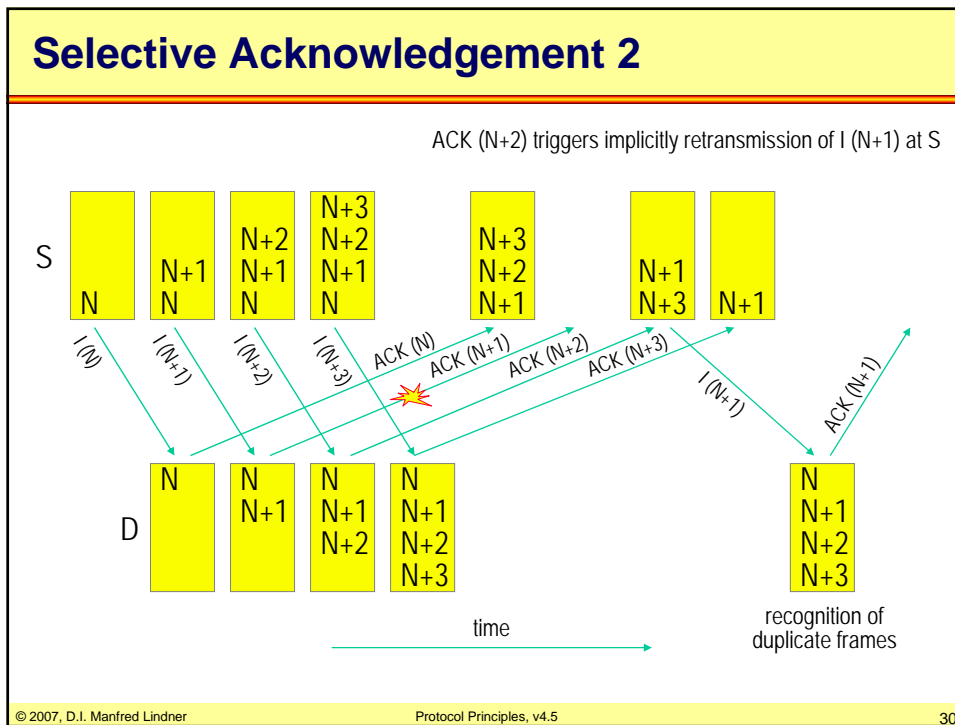
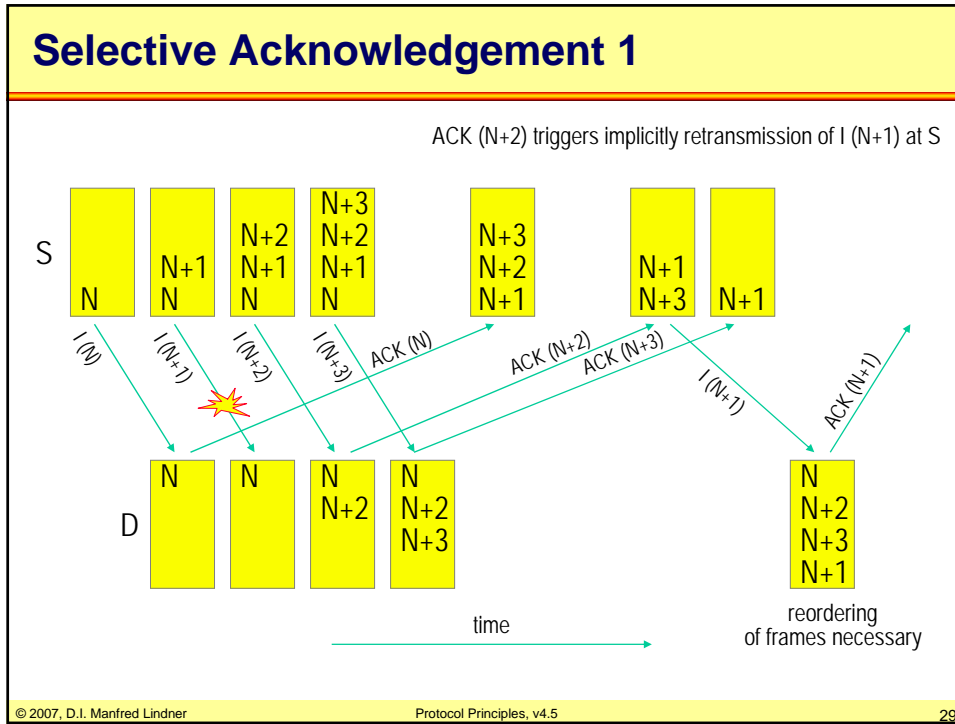

L02 - Protocol Principles

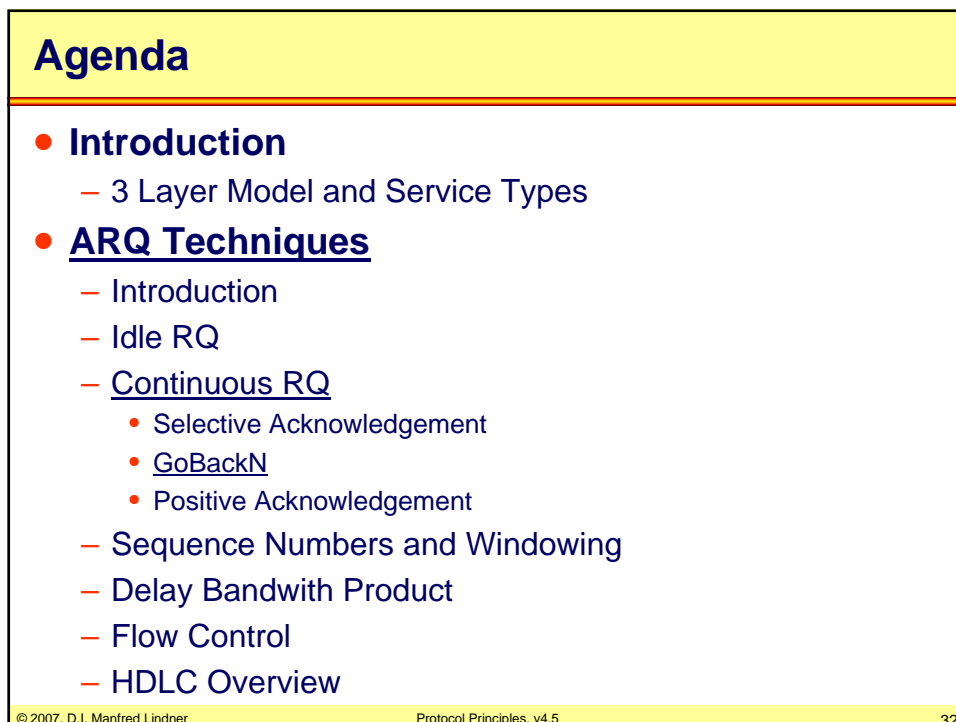
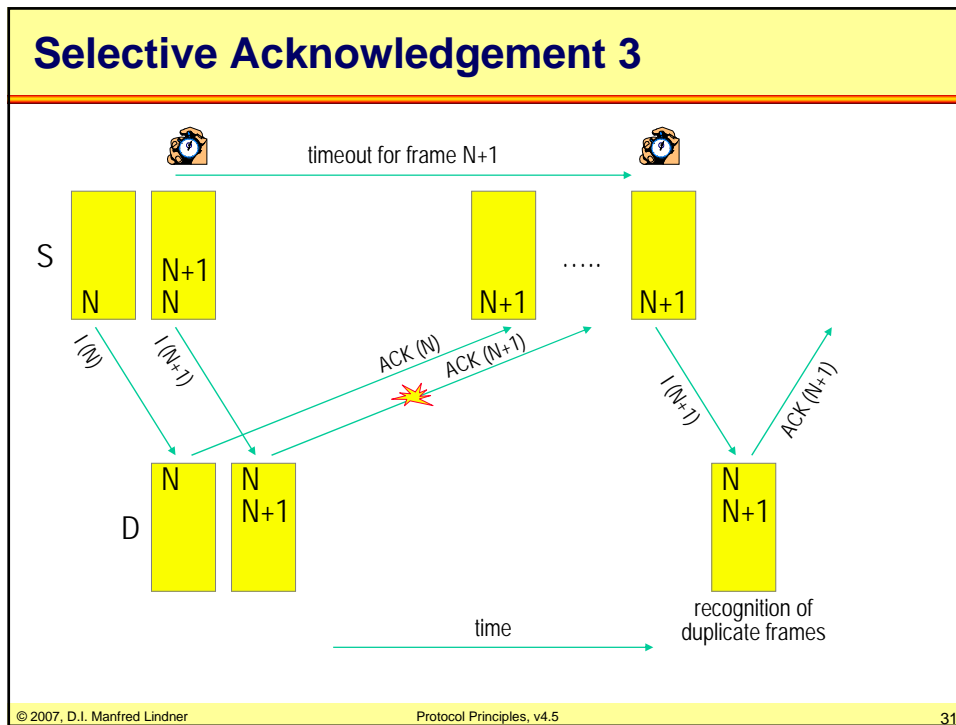

L02 - Protocol Principles

GoBackN

- **principle**

- in case of errors, all data frames since “N” will be requested again by NACK(N) (Negative Ack.)
- all following frames are discarded by receiver until frame with correct sequence number arrives
 - reordering is not necessary in this case
 - SW at receiver could be kept more simple
- a single acknowledgments could confirm multiple data frames (multiple acknowledgement)
 - often use to spare number of Ack's in opposite direction
- each transmitted data frame starts an individual timer
 - which will be reset, if acknowledgement is received
 - if timeout occurs data frame is sent once again (scenario 3)

© 2007, D.I. Manfred Lindner

Protocol Principles, v4.5

33

GoBackN 1

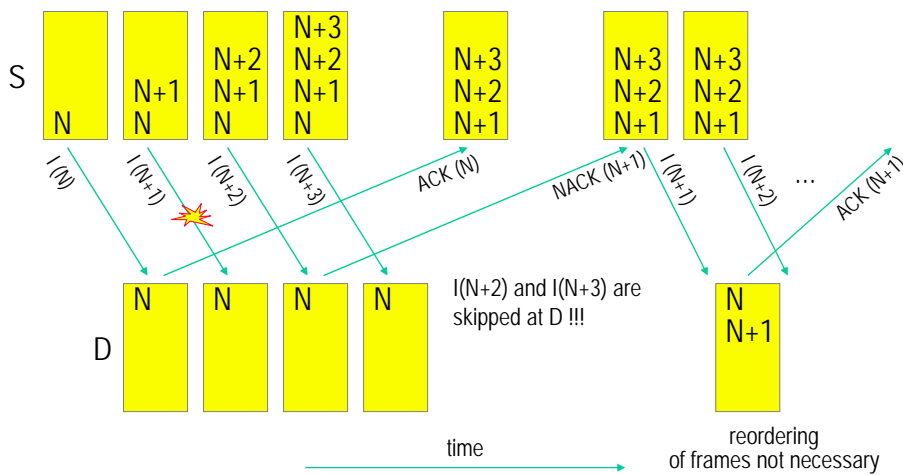

© 2007, D.I. Manfred Lindner

Protocol Principles, v4.5

34

L02 - Protocol Principles

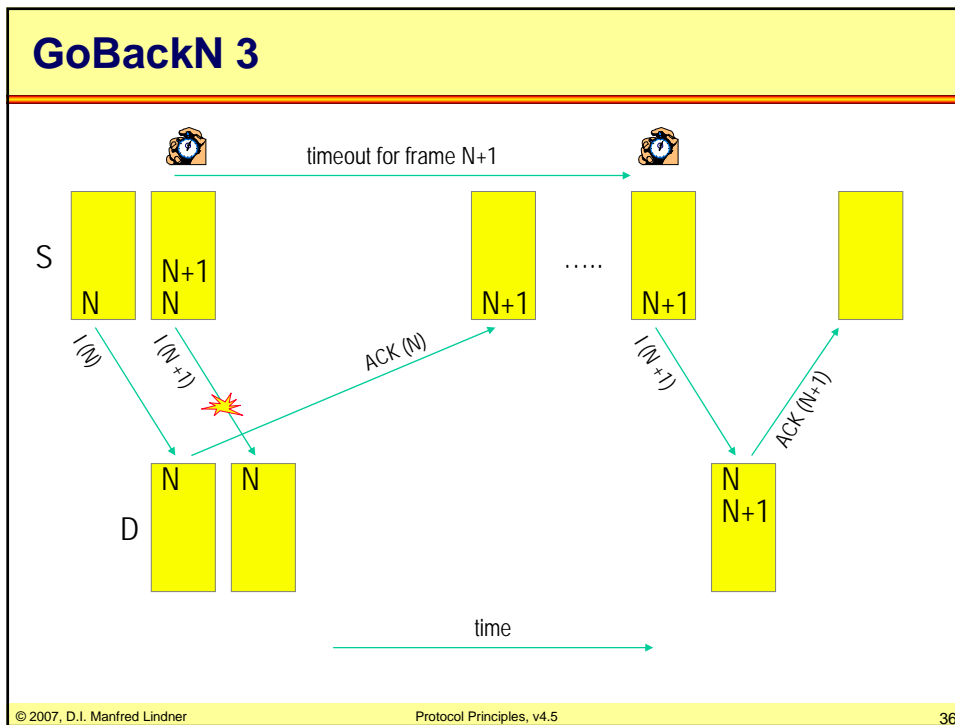
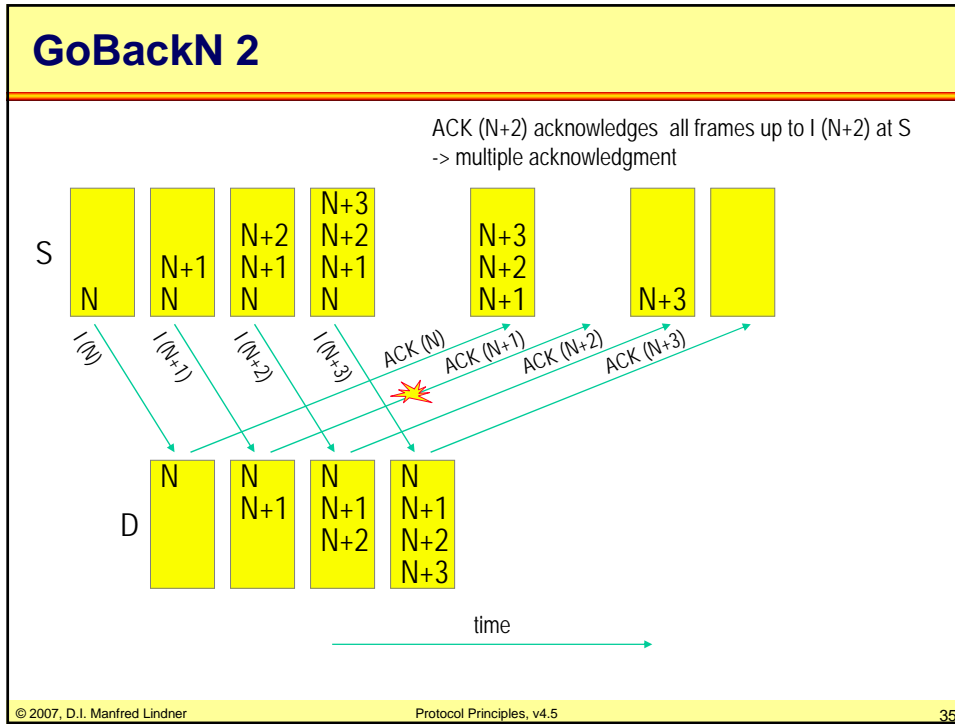

L02 - Protocol Principles

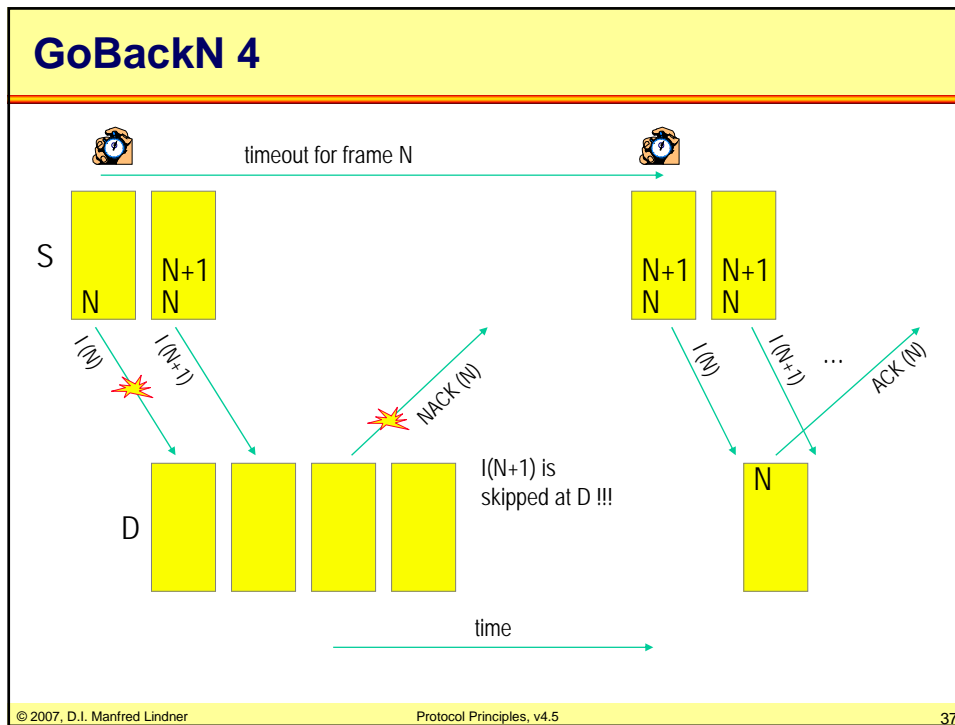

Agenda

- **Introduction**
 - 3 Layer Model and Service Types
- **ARQ Techniques**
 - Introduction
 - Idle RQ
 - Continuous RQ
 - Selective Acknowledgement
 - GoBackN
 - Positive Acknowledgement
 - Sequence Numbers and Windowing
 - Delay Bandwidth Product
 - Flow Control
 - HDLC Overview

L02 - Protocol Principles

Positive Acknowledgement

- **principle**

- data frames will be confirmed as long as frames arrives in sequence
 - multiple acknowledgement can be used by receiver
- if data frames get out of sequence, confirmation is stopped
- nevertheless, all following data frames will be stored
- each transmitted data frame starts an individual timer
 - which will be reset, if acknowledgement is received
 - if timeout occurs data frame is sent once again (scenario 1)
- data frames which are already stored in the receiver
 - can be confirmed with multiple acknowledgements when missing data frame arrives (scenario 1)

© 2007, D.I. Manfred Lindner

Protocol Principles, v4.5

39

Positive Acknowledgement 1

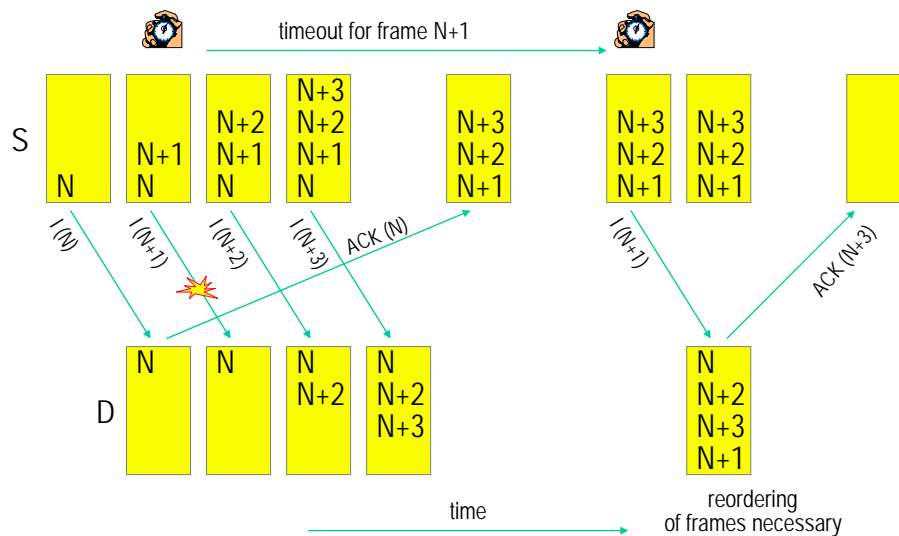

© 2007, D.I. Manfred Lindner

Protocol Principles, v4.5

40

L02 - Protocol Principles

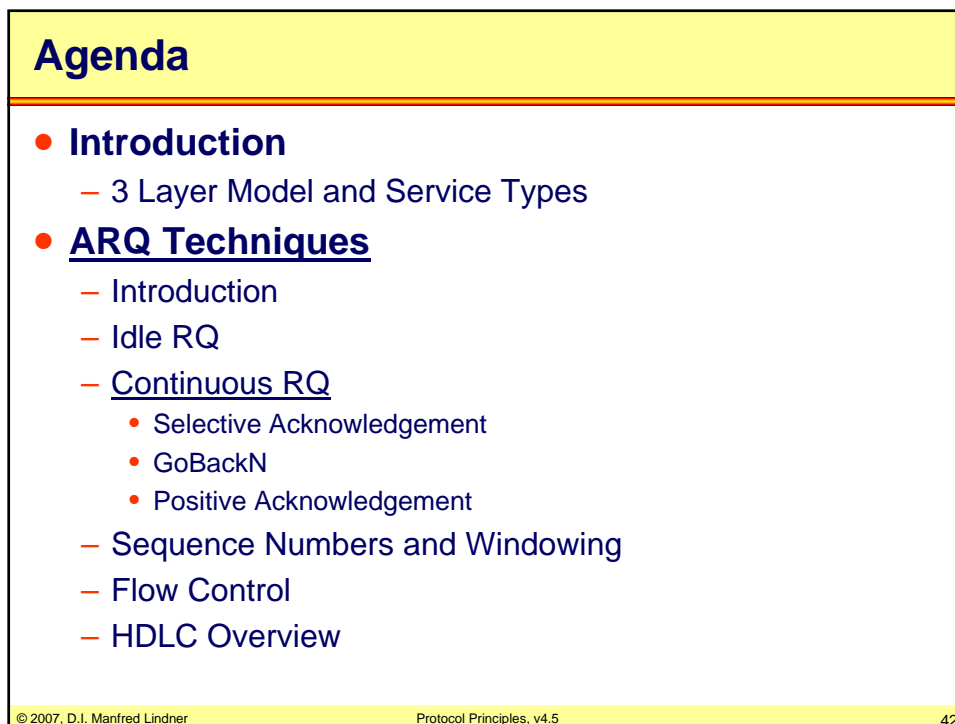
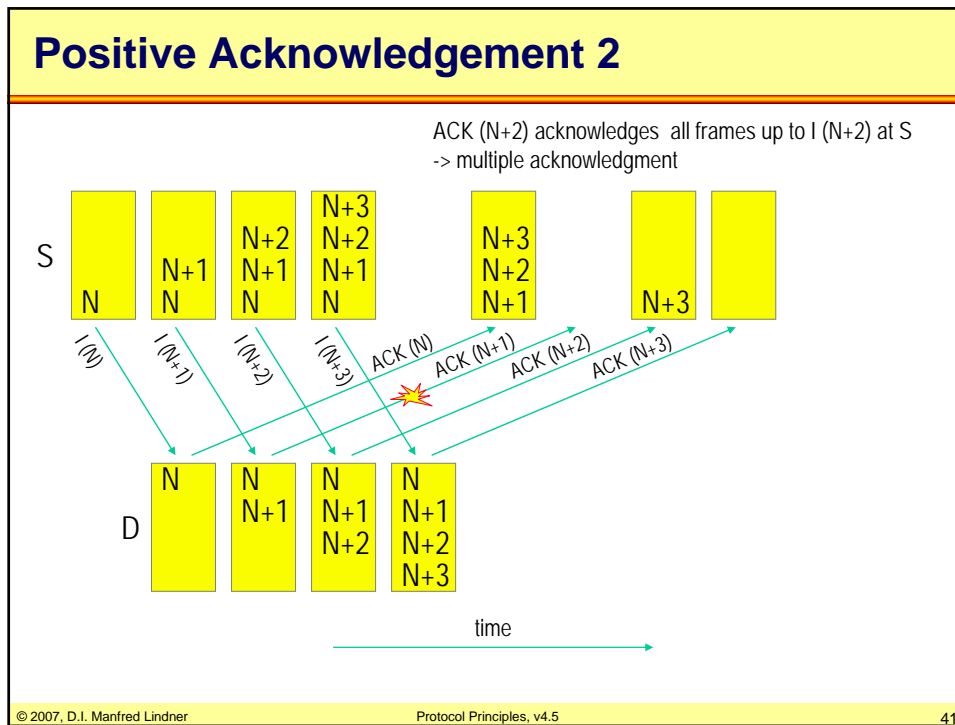

L02 - Protocol Principles

Agenda

- **Introduction**
 - 3 Layer Model and Service Types
- **ARQ Techniques**
 - Introduction
 - Idle RQ
 - Continuous RQ
 - Selective Acknowledgement
 - GoBackN
 - Positive Acknowledgement
 - Sequence Numbers and Windowing
 - Delay Bandwidth Product
 - Flow Control
 - HDLC Overview

© 2007, D.I. Manfred Lindner

Protocol Principles, v4.5

43

Sequence Number

- **identifiers of data frames are implemented by increasing numbers**
 - sequence numbers
 - the number used in I-frames
 - send sequence number N(S)
 - the number used in ACK/NACK/SREJ-frames
 - receive sequence number N(R)
 - register variables are necessary
 - V(S), V(R)
 - must be initialized (set to 0) by connection setup
 - handling of V(S), V(R), N(S), and N(R) will be explained in next slides for GoBackN

© 2007, D.I. Manfred Lindner

Protocol Principles, v4.5

44

L02 - Protocol Principles

V(S), V(R) with GoBackN

- **V(S) indicates the sequence number of the next I-frame that will be sent**
- **V(R) indicates the expected sequence number of the next in-sequence I-frame to be received**
 - this value will be seen in N(R)
- **prior to sending an I-frame, the value of N(S) is set to the value of V(S)**
 - afterwards V(S) is increased by one

© 2007, D.I. Manfred Lindner

Protocol Principles, v4.5

45

V(S), V(R) with GoBackN

- **receiver only accepts I-frames with $N(S) = V(R)$**
 - after successful receipt of a frame V(R) will first be increased by one and then acknowledgment with $N(R) = V(R)$ will be sent
- **therefore receipt of ACK with $N(R) = x$ means**
 - that all I-frames until $x-1$ are confirmed

© 2007, D.I. Manfred Lindner

Protocol Principles, v4.5

46

L02 - Protocol Principles

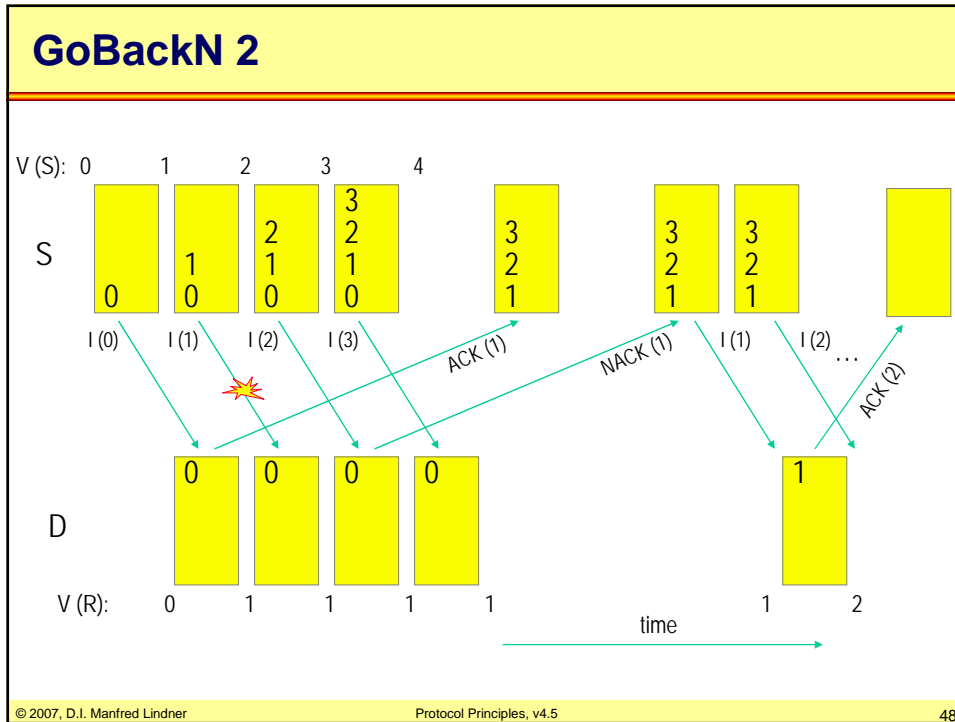
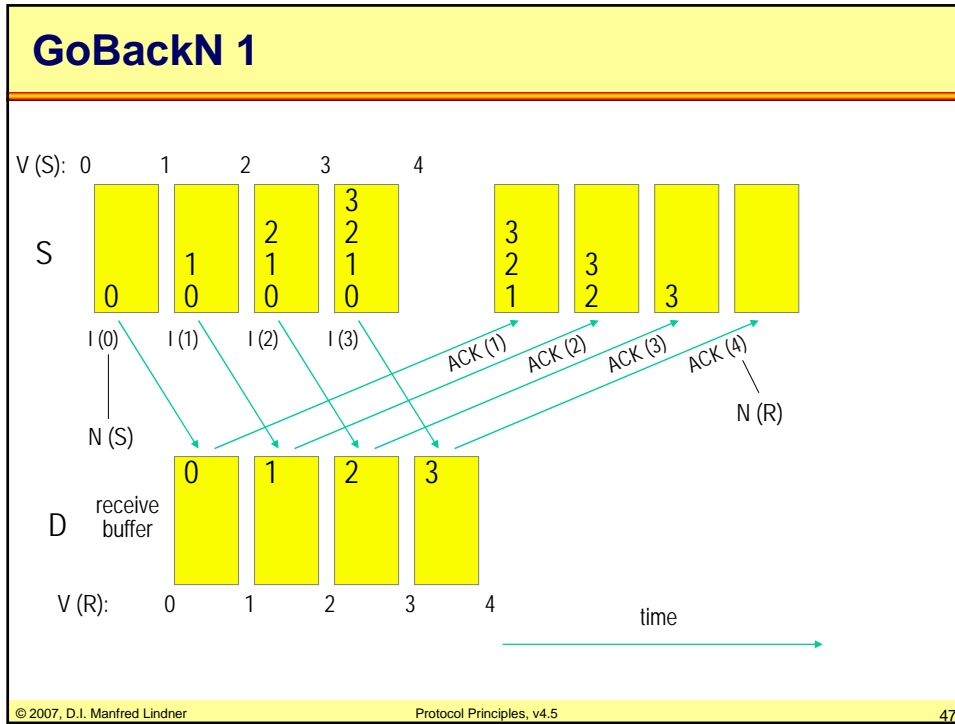

L02 - Protocol Principles

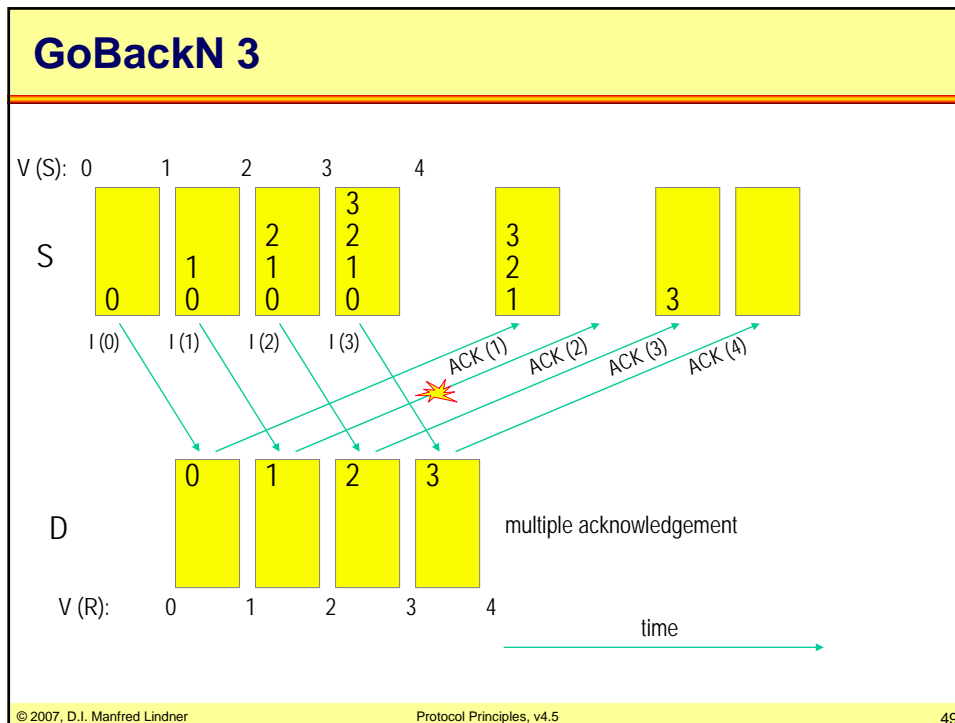

Initializing / Transmission Pause

- **connection establishment initializes V(S) and V(R)**
- **after connection establishment**
 - connection is maintained by keepalive messages during transmission pauses
- **example for keepalive technique**
 - exchange of HELLO (request / poll) and ACK (response)
 - ACK is used for acknowledgment as well as for connection maintenance
 - because of this an ACK(N) only confirms all frames up to N-1 and not up to N
 - sender can distinguish between a keepalive response and acknowledgement of a new data frame

L02 - Protocol Principles

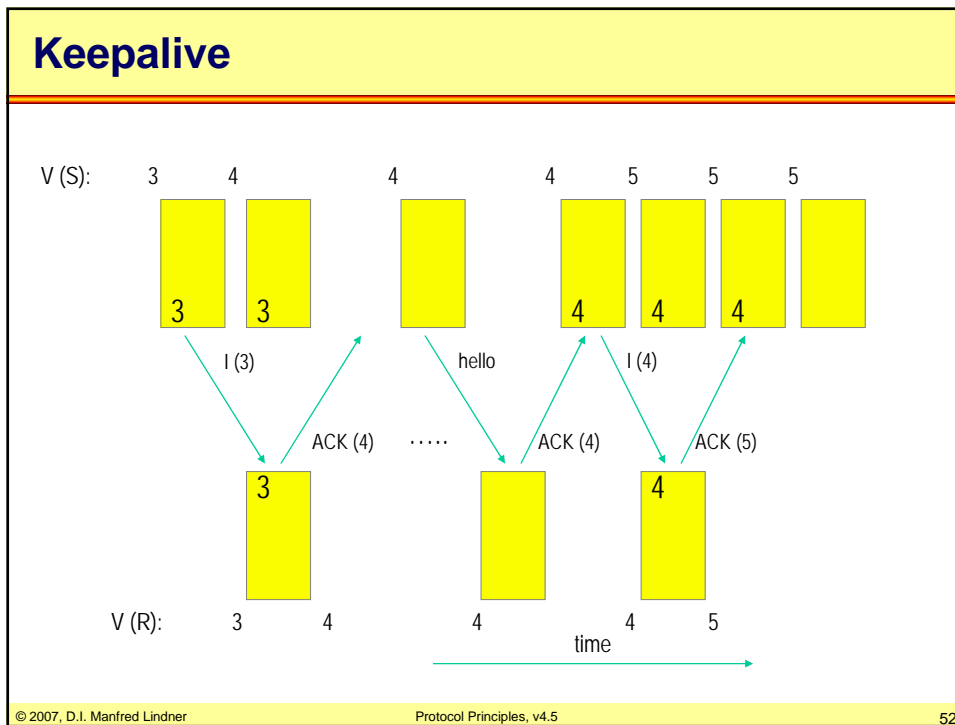
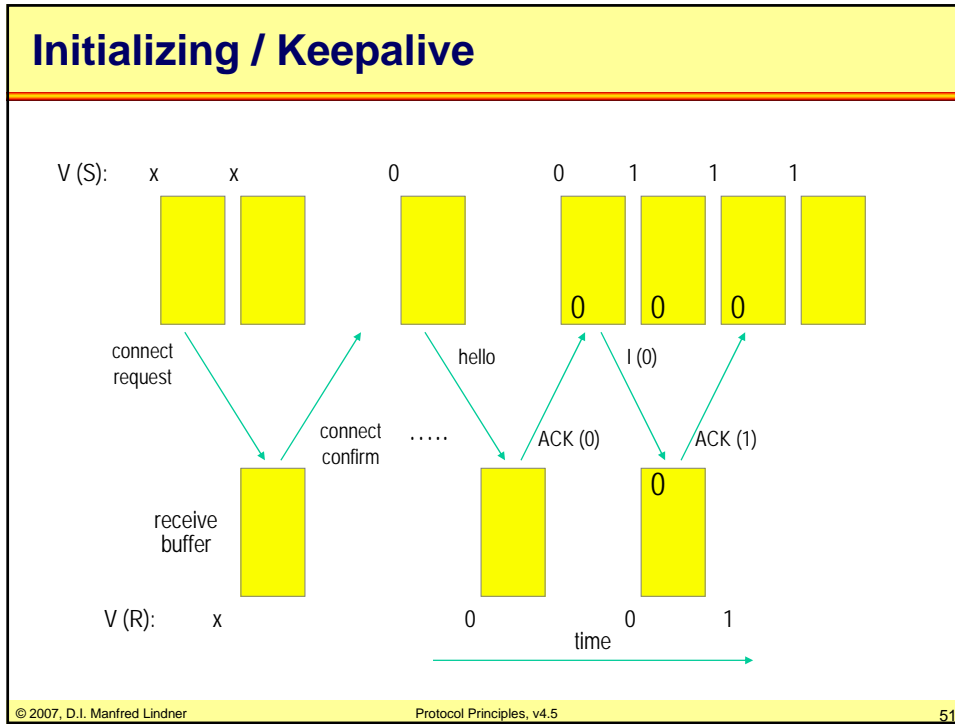

L02 - Protocol Principles

Piggyback Acknowledgement

- confirmation of every data frame is only appropriate for data flow in one direction
- acknowledgment frames produce unnecessary overhead with full duplex data traffic
- acknowledgments contained in data frames in opposite direction can avoid that overhead
 - piggyback acknowledgement
- if no backward data frame is waiting for transmission
 - ACK frame will be sent still

© 2007, D.I. Manfred Lindner

Protocol Principles, v4.5

53

Piggyback Acknowledgement

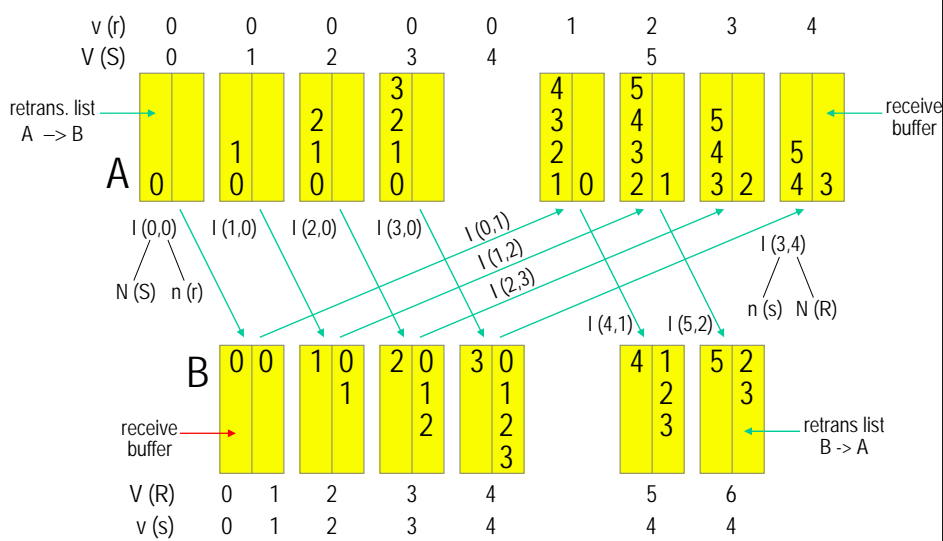

© 2007, D.I. Manfred Lindner

Protocol Principles, v4.5

54

L02 - Protocol Principles

Data Flow in both Directions

- data frames contain both send sequence number and receive sequence number of backward direction
- now I-frames and ACK/NACK-frames can arise in both directions
- communication devices must contain both V(S)- and V(R)-registers, retransmission and receive lists
- N(S), N(R), V(S) und V(R) control data transfer from A to B
- n(s), n(r), v(s) und v(r) control data transfer from B to A

© 2007, D.I. Manfred Lindner

Protocol Principles, v4.5

55

Windowing

- without a restriction of the number of unconfirmed data frames, continuous-RQ would require infinite number of identifiers and buffer memory
- for that reason, the amount W of data frames stored for retransmission must be limited
 - W = send window
- if limit is reached, sending of additional data frames is stopped until receipt of acknowledgement indicates that window is opened again
 - windowing

© 2007, D.I. Manfred Lindner

Protocol Principles, v4.5

56

L02 - Protocol Principles

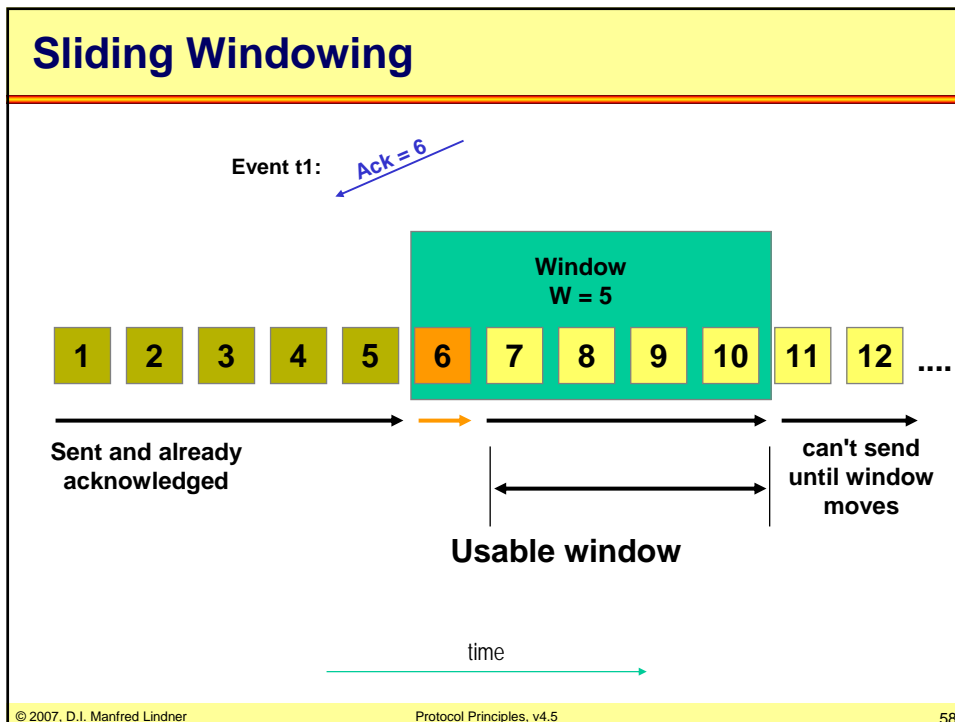
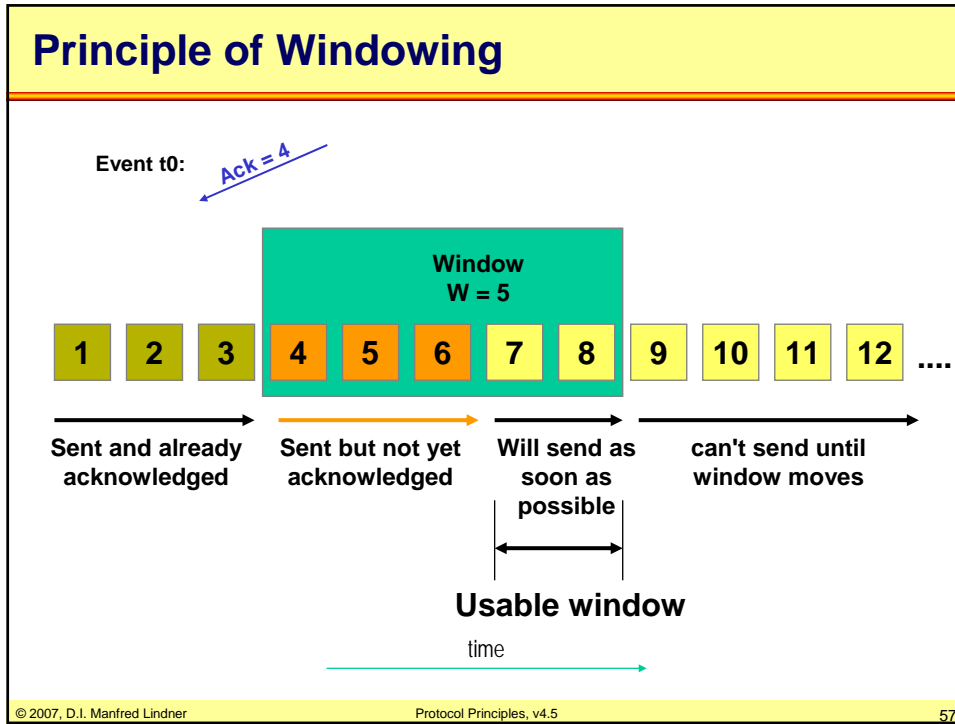

L02 - Protocol Principles

Consequences of Windowing

- **windowing reduces the buffer memory for retransmission buffer and receive-list**
 - buffer size of retransmission buffer = $W * \text{maximum frame size}$
- **windowing reduces the number of identifiers**
 - numbering of data frames can be done by a modulo operation
 - e.g. GoBackN with send window = W
 - needs $W+1$ identifiers because of worst case scenario next slide
 - data frames can be numbered modulo $W+1$
 - e.g. Selective Acknowledgement with send window = W
 - needs $2W$ identifiers because of worst case scenario
 - data frames can be numbered modulo $2W$

© 2007, D.I. Manfred Lindner

Protocol Principles, v4.5

59

Windowing with Numbering Modulo $W+1$

GoBackN and send-window W means $W+1$ Identifier and numbering with modulo $W+1$

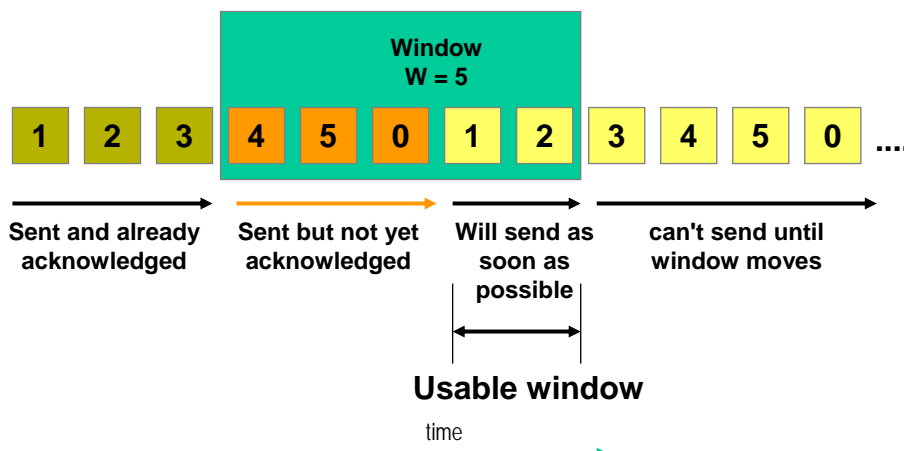

© 2007, D.I. Manfred Lindner

Protocol Principles, v4.5

60

L02 - Protocol Principles

Agenda

- **Introduction**
 - 3 Layer Model and Service Types
- **ARQ Techniques**
 - Introduction
 - Idle RQ
 - Continuous RQ
 - Selective Acknowledgement
 - GoBackN
 - Positive Acknowledgement
 - Sequence Numbers and Windowing
 - Delay Bandwith Product
 - Flow Control
 - HDLC Overview

© 2007, D.I. Manfred Lindner

Protocol Principles, v4.5

61

Time to Transmit a given Number of Bytes

$$\text{Serialization Delay (in ms)} = [(\text{Number of Bytes} * 8) / (\text{Bitrate in sec})] * 1000$$

	Bitrate	9,6 kbit/s	48 kbit/s	128 kbit/s	2,048 Mbit/s	10 Mbit/s	100 Mbit/s	155 Mbit/s	622 Mbit/s	1 Gigabit/s
	Number of Byte	Delay in msec (10 ⁻³)	Delay in msec (10 ⁻³)	Delay in msec (10 ⁻³)	Delay in msec (10 ⁻³)	Delay in msec (10 ⁻³)	Delay in msec (10 ⁻³)	Delay in msec (10 ⁻³)	Delay in msec (10 ⁻³)	Delay in msec (10 ⁻³)
Bit	0,125	0,104167	0,020833	0,007813	0,000488	0,000100	0,000010	0,000006	0,000002	0,000001
Byte	1	0,833333	0,166667	0,062500	0,003906	0,000800	0,000080	0,000052	0,000013	0,000008
PCM-30	32	26,666667	5,333333	2,000000	0,125000	0,025600	0,002560	0,001652	0,000412	0,000256
ATM cell	53	44,166667	8,833333	3,312500	0,207031	0,042400	0,004240	0,002735	0,000682	0,000424
Ethernet	64	53,333333	10,666667	4,000000	0,250000	0,051200	0,005120	0,003303	0,000823	0,000512
X.25	256	213,333333	42,666667	16,000000	1,000000	0,204800	0,020480	0,013213	0,003293	0,002048
IP	576	480,000000	96,000000	36,000000	2,250000	0,460800	0,046080	0,029729	0,007408	0,004608
Ethernet	1.518	1.265,000000	253,000000	94,875000	5,929688	1,214400	0,121440	0,078348	0,019524	0,012144
FR	8.192	6.826,666667	1.365,333333	512,000000	32,000000	6,553600	0,655360	0,422813	0,105363	0,065536
TCP	65.534	54.611,666667	10.922,333333	4.095,875000	255,992188	52,427200	5,242720	3,382400	0,842881	0,524272

1kbit/s = 1000 bit/s !!!
1KByte = 1024 Byte !!!

© 2007, D.I. Manfred Lindner

Protocol Principles, v4.5

62

L02 - Protocol Principles

Propagation (Signal) Delay

$$T_p = \text{Propagation Delay (in ms)} = [(\text{Distance in m}) / (\text{velocity in m/sec})] * 1000$$

	Distance	v=200.000km/s	v=300.000km/s
		Delay in msec (10 ⁻³)	Delay in msec (10 ⁻³)
CPU Bus	10 cm	0,0000005	0,0000003
	1 m	0,0000050	0,0000033
RS232, V24/V.28	15 m	0,0000750	0,0000500
LAN, Copper, RJ45	100 m	0,0005000	0,0003333
LAN, FO, X.21/V.11-V.10	1 km	0,0050000	0,0033333
Local Subscriber Line	2,5 km	0,0125000	0,0083333
WAN Link Repeater	10 km	0,0500000	0,0333333
WAN Link Repeater	100 km	0,5000000	0,3333333
WAN FO Link Repeater	1.000 km	5,0000000	3,3333333
WAN FO Link Repeater	10.000 km	50,0000000	33,3333333
Satellite Link	40.000 km	200,0000000	133,3333333
Satellite Link	50.000 km	250,0000000	166,6666667
	100.000 km	500,0000000	333,3333333
	300.000 km	1500,0000000	1000,0000000

$$\text{Total Delay} = \text{Serialization Delay} + \text{Propagation Delay} + (\text{Switching Delay})$$

How Long is a Bit?

$$\text{Length (in m)} = [(1 / (\text{bitrate per sec})) * (\text{velocity in m/sec})]$$

	Bitrate	Bit Length in meter	Bit Length in meter
Analogue Modem	9,6 kbit/s	20833,33	31250,00
Analogue Modem	48 kbit/s	4166,67	6250,00
DS0	64 kbit/s	3125,00	4687,50
ISDN (2B)	128 kbit/s	1562,50	2343,75
PCM-30, E1	2,048 Mbit/s	97,66	146,48
Token Ring 4	4 Mbit/s	50,00	75,00
Ethernet	10 Mbit/s	20,00	30,00
Token Ring16	16 Mbit/s	12,50	18,75
Fast Ethernet, FDDI	100 Mbit/s	2,00	3,00
ATM STM1, OC-3	155 Mbit/s	1,29	1,94
ATM STM4, OC-12	622 Mbit/s	0,32	0,48
Gigabit Ethernet	1 Gigabit/s	0,20	0,30
OC-48	2,5 Gigabit/s	0,08	0,12
10 Gigabit Ethernet	10 Gigabit/s	0,02	0,03
		Copper	LWL - Free Space
		200.000 km /sec	300.000 km / sec

L02 - Protocol Principles

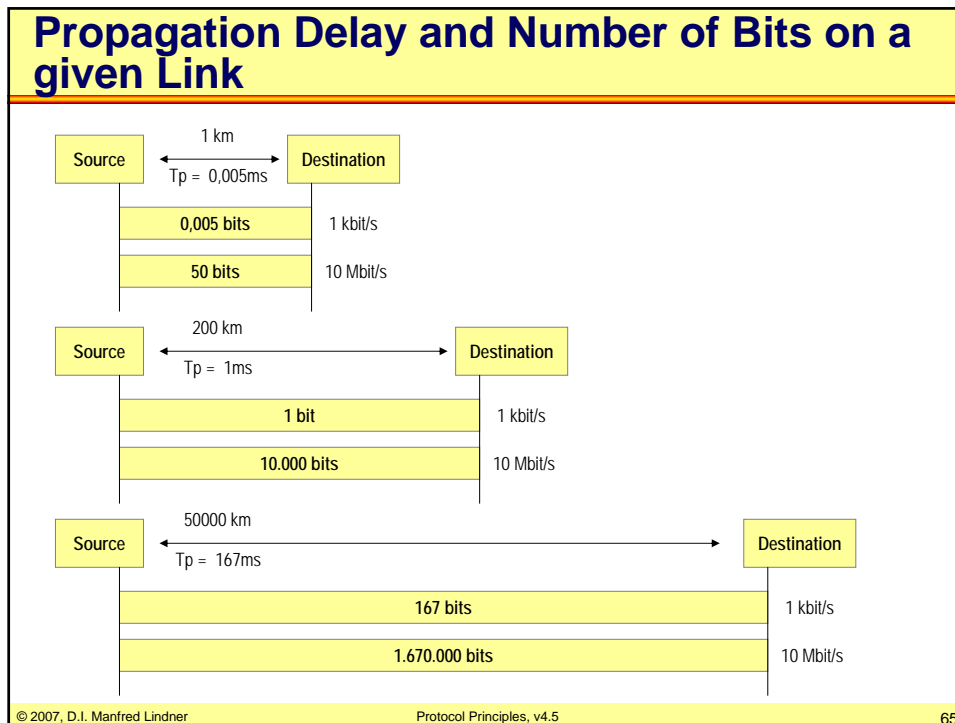

How Large should be the Window Size?

- **choice of window size is determined by**
 - response time (= round trip time RTT)
 - 2 x (propagation + serialization) delay plus response delay of partner
 - bandwidth (bit rate) of communication channel
 - [available buffer size transmitter/receiver]
 - **principle to achieve the optimum:**
 - the sender's window must be big enough so that the sender can fully utilize the channel volume
 - the channel volume can be expressed by the **Delay-Bandwidth Product**
- window size W in bytes = $RTT \times BW$

L02 - Protocol Principles

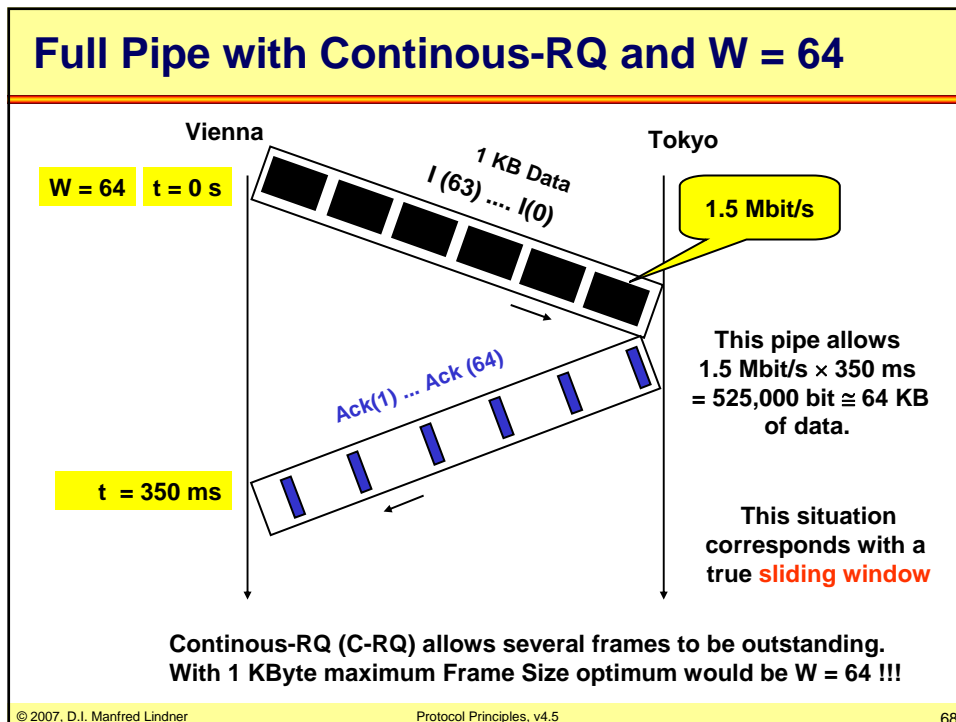
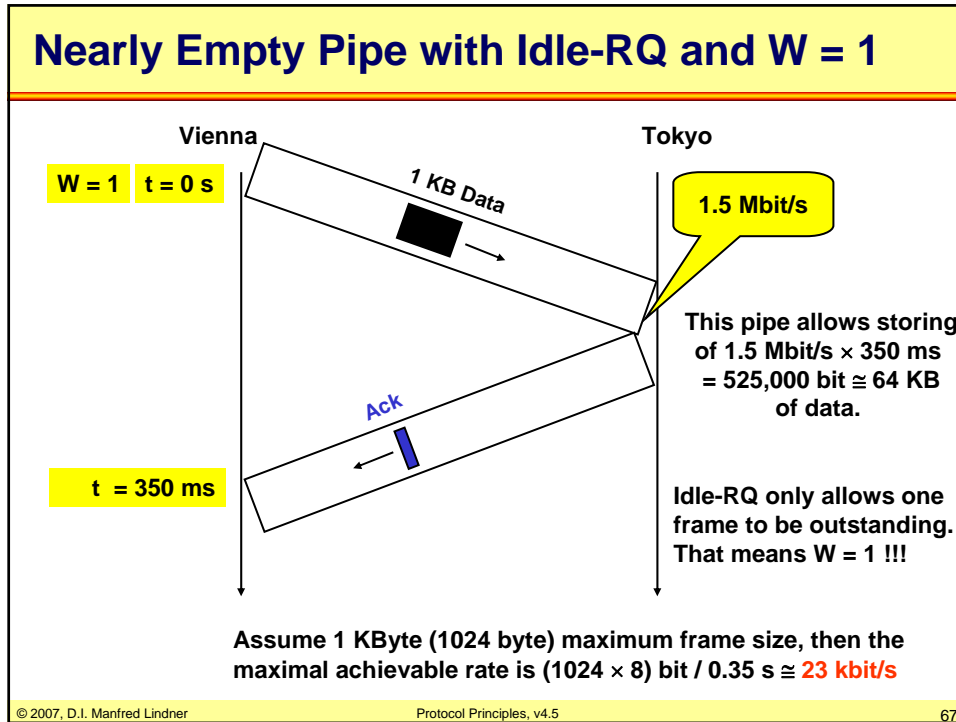

L02 - Protocol Principles

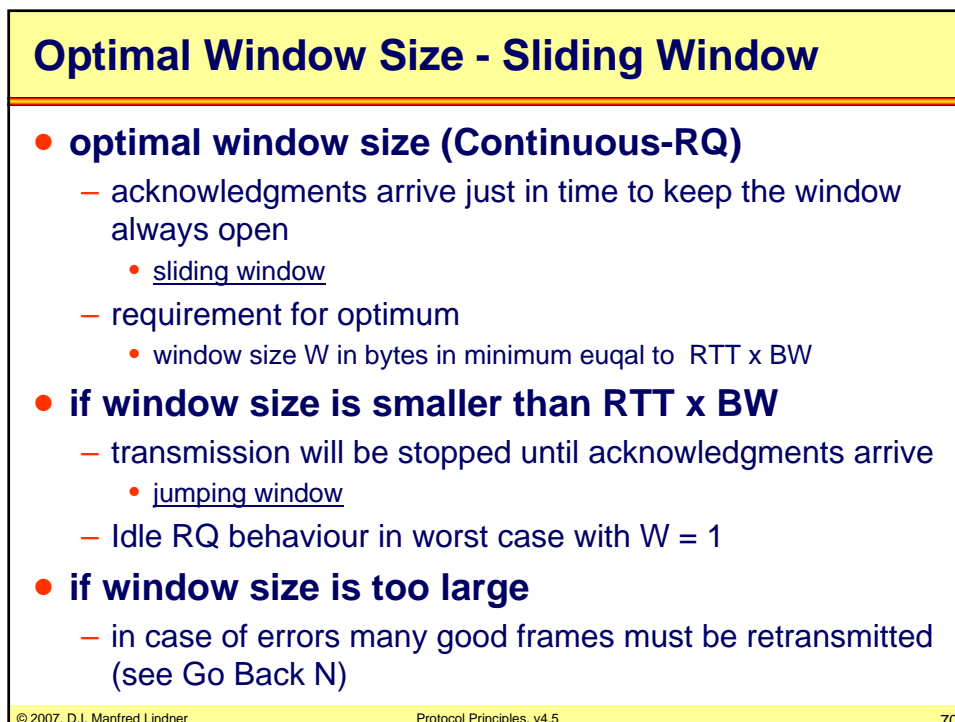
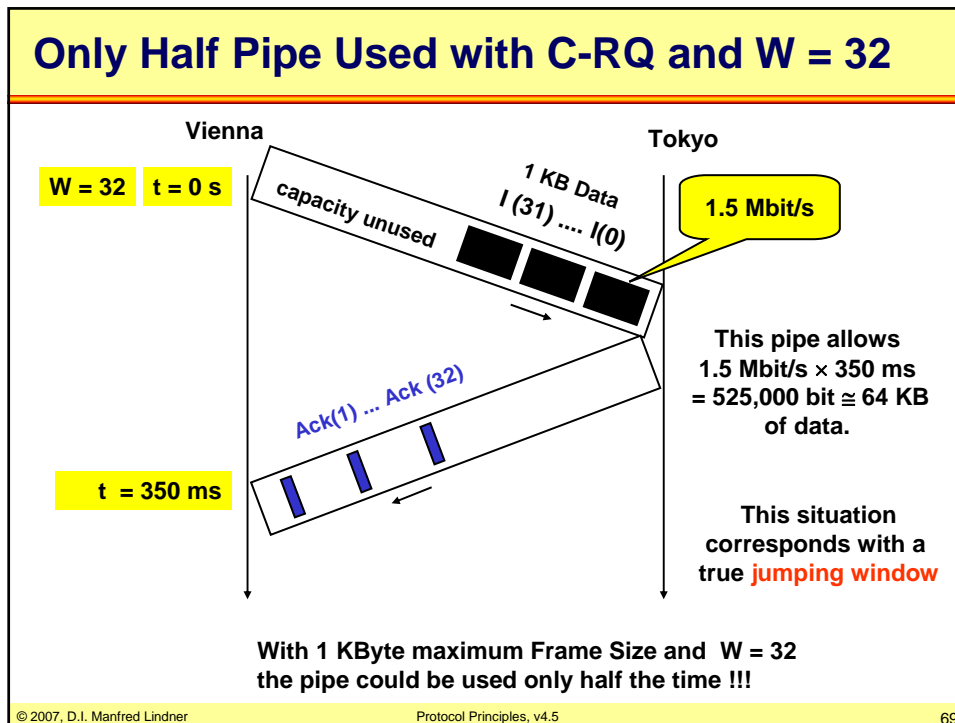

L02 - Protocol Principles

Timers - Retransmission Timeout

- **the value for retransmission timeouts with line protocols can be easily calculated using the following parameters**
 - bitrate
 - maximum data frame size
 - worst case time at receiver to generate an acknowledgment
 - size of acknowledgment frame
- **calculation for network protocols with varying transmission delays is more complex**
 - adaptive process is necessary

© 2007, D.I. Manfred Lindner

Protocol Principles, v4.5

71

Agenda

- **Introduction**
 - 3 Layer Model and Service Types
- **ARQ Techniques**
 - Introduction
 - Idle RQ
 - Continuous RQ
 - Selective Acknowledgement
 - GoBackN
 - Positive Acknowledgement
 - Sequence Numbers and Windowing
 - Delay Bandwidth Product
 - Flow Control
 - HDLC Overview

© 2007, D.I. Manfred Lindner

Protocol Principles, v4.5

72

L02 - Protocol Principles

Flow Control

- **if data frames arrive faster than application is able to process,**
 - receiver runs out of available buffer storage and good frames must be discarded by the receiver
 - discarded data frames will cause retransmission but they will be still discarded because of lack of buffers
- **therefore receiver should control the rate of transmission of data frames**
 - flow control
 - overload/congestion situation indicated to the sender using flow control messages
 - sender stops and waits until receiver is able to process frames again

© 2007, D.I. Manfred Lindner

Protocol Principles, v4.5

73

Flow Control

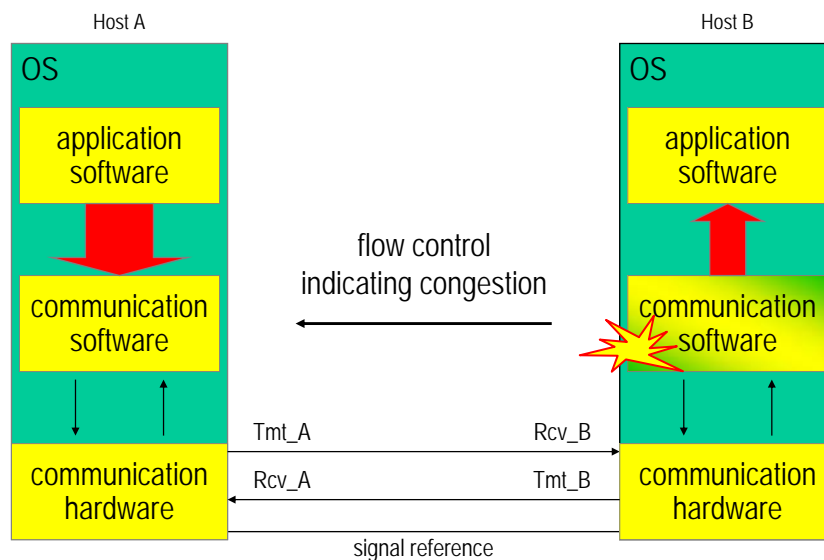

© 2007, D.I. Manfred Lindner

Protocol Principles, v4.5

74

L02 - Protocol Principles

Flow Control

- **windowing could be used to implement flow control**
 - receiver does not generate acknowledgements in case of congestion
 - sender will stop transmission if send window is closed
- **problem with windowing**
 - after timeout unconfirmed frames will be retransmitted
 - after a defined amount of unsuccessful retransmissions, the connection is considered to be broken
- **therefore flow control is based on**
 - separate flow control frames
 - and windowing

© 2007, D.I. Manfred Lindner

Protocol Principles, v4.5

75

Flow Control

- **typically used flow control messages**
 - STOP, e.g. HDLC's Receiver Not Ready (RNR)
 - GO, e.g. HDLC's Receiver Ready (RR)
- **in case of congestion**
 - receiver signals STOP
 - on receipt of STOP sender will suspend transmitting
 - in the worst case, sender will use the send window before stopping transmission
 - receiver signals GO when data flow can resume
 - STOP and GO may contain N(R) and hence be used for acknowledgement

© 2007, D.I. Manfred Lindner

Protocol Principles, v4.5

76

L02 - Protocol Principles

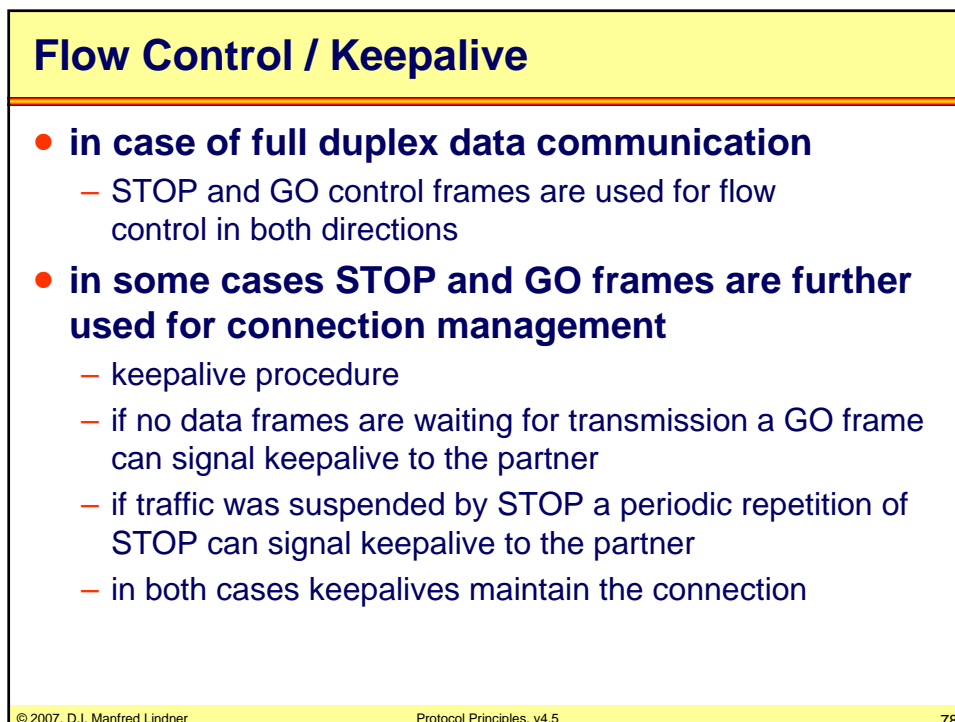
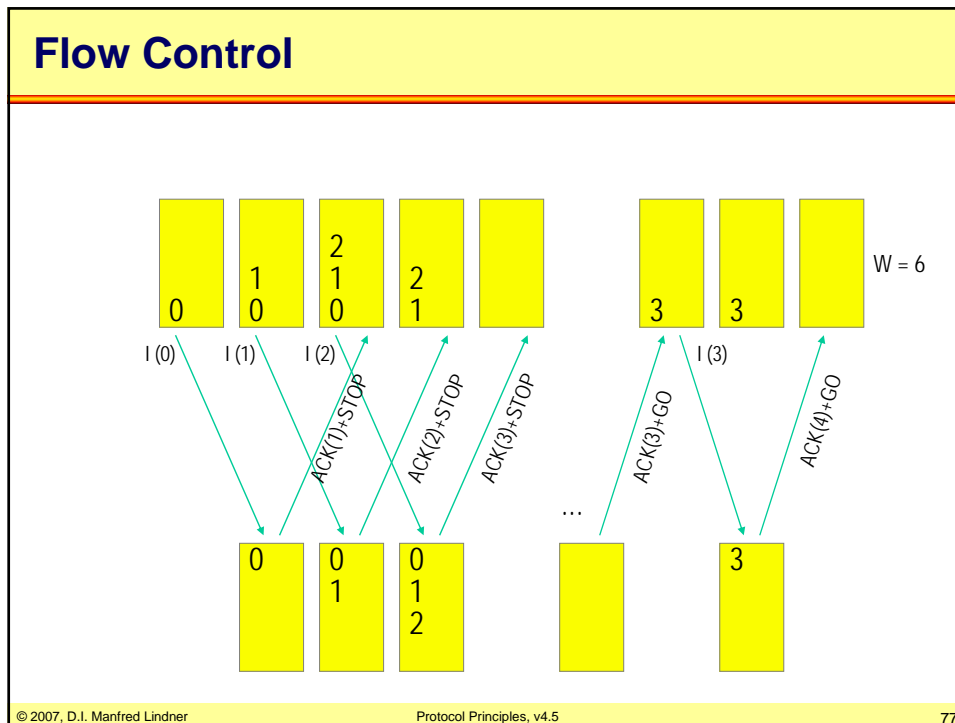

L02 - Protocol Principles

Flow Control / Adaptive Windowing

- **window size could be**
 - constant or dynamic during lifetime of a connection
 - constant window size is used e.g. by HDLC, X.25
- **if window size is dynamic**
 - a start value is negotiated during connection establishment
 - actual window size will be dynamically adjusted to an optimal value
 - receiver continuously advertises optimal value (e.g. based on availability free buffer memory)
 - advertised window size = 0 -> STOP
 - advertised window size > 0 -> GO
 - adaptive windowing
 - e.g used by TCP

© 2007, D.I. Manfred Lindner

Protocol Principles, v4.5

79

Agenda

- **Introduction**
 - 3 Layer Model and Service Types
- **ARQ Techniques**
 - Introduction
 - Idle RQ
 - Continuous RQ
 - Selective Acknowledgement
 - GoBackN
 - Positive Acknowledgement
 - Sequence Numbers and Windowing
 - Delay Bandwidth Product
 - Flow Control
 - HDLC Overview

© 2007, D.I. Manfred Lindner

Protocol Principles, v4.5

80

L02 - Protocol Principles

HDLC

- **H**i**g**-**l**e**v****e****l** **D**a**t****a** **L**i**n****k** **C**o**n****t****r****o****l**
- **most widely used data link control protocol based on building elements**
 - synchronous transmission
 - bit-oriented line protocol using bitstuffing
 - Continuous RQ with GoBackN, piggybacked ACK
 - P/F procedure (see appendix chapter for details)
- **provides many options**
 - half-duplex and full-duplex transmission (see appendix chapter for details)
 - point-to-point and multipoint configuration (see appendix chapter for details)
 - switched or non-switched channels

© 2007, D.I. Manfred Lindner

Protocol Principles, v4.5

81

HDLC Frame Format

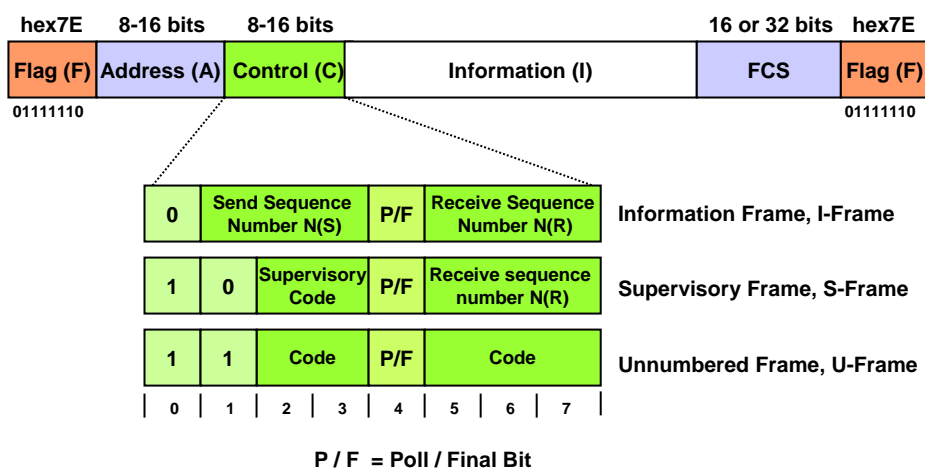

© 2007, D.I. Manfred Lindner

Protocol Principles, v4.5

82

L02 - Protocol Principles

Supervisory Frames

1	0	Supervisory Code	P/F	Receive Sequence Number N(R)
		0	0	RR (Receiver Ready) = meaning of ACK plus GO
		0	1	REJ (Reject) = meaning of NACK
		1	0	RNR (Receiver Not Ready) = meaning ACK plus STOP
		1	1	SREJ (Selective Reject)

HDLC Data Link Services

- **HDLC can provide connection-oriented service**
 - setup of connection done by U-frames
 - SNRM, SARM, SABM, UA
 - I-frames and S-frame can be used only after connection setup
 - I, RR, RNR, REJ, SREJ
 - clearing of a connection done by U-frames
 - DISC, UA
- **HDLC can provide connectionless service**
 - only U-frames can be used
 - UI for data transport

L02 - Protocol Principles

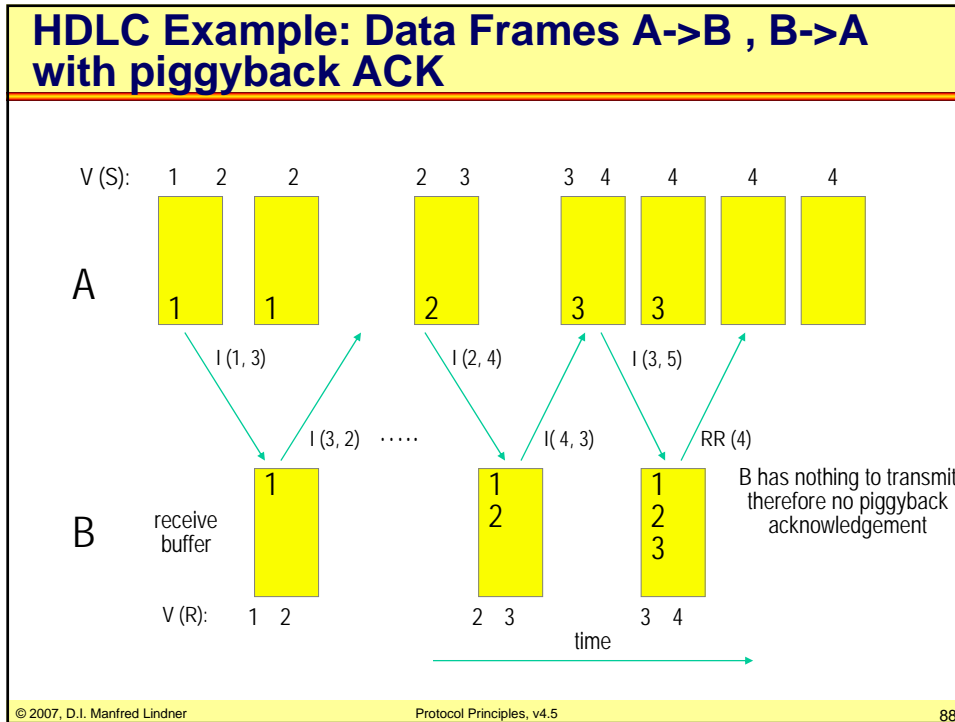
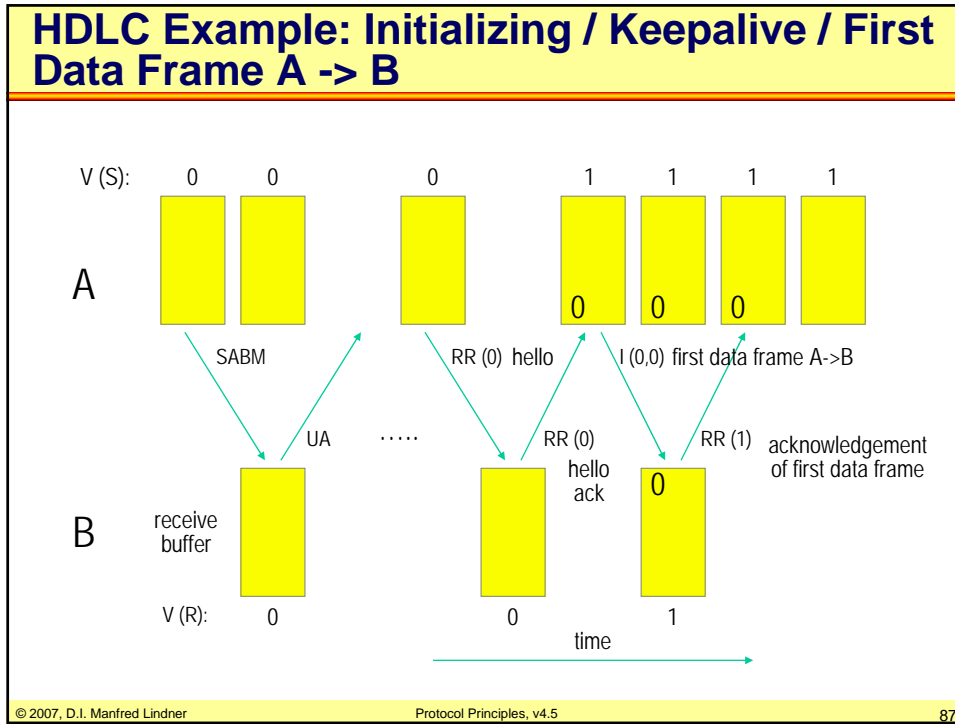

L02 - Protocol Principles

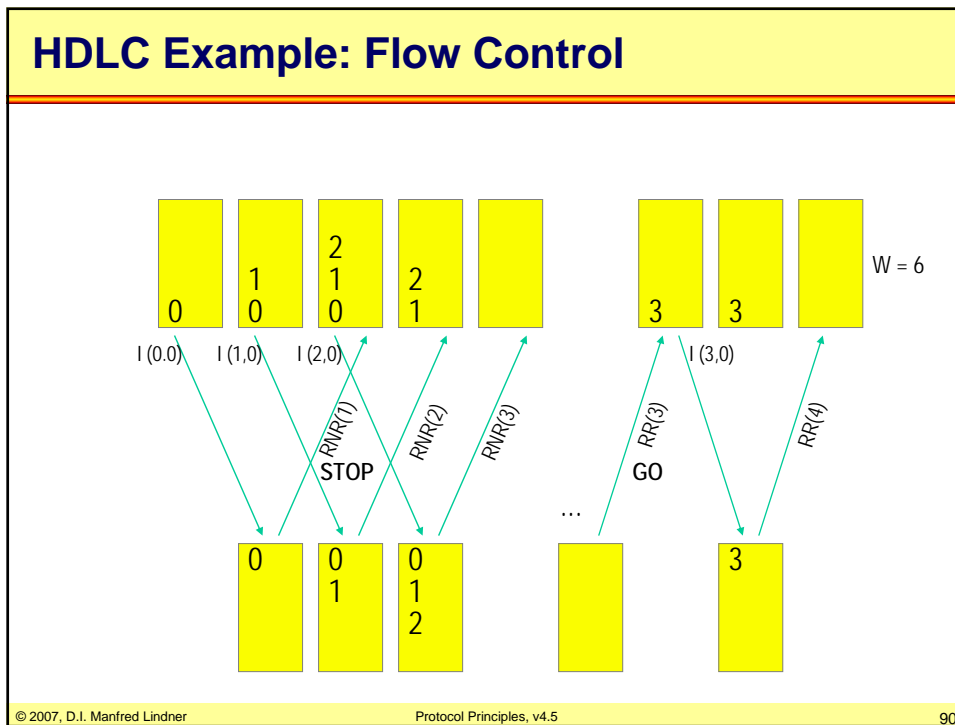
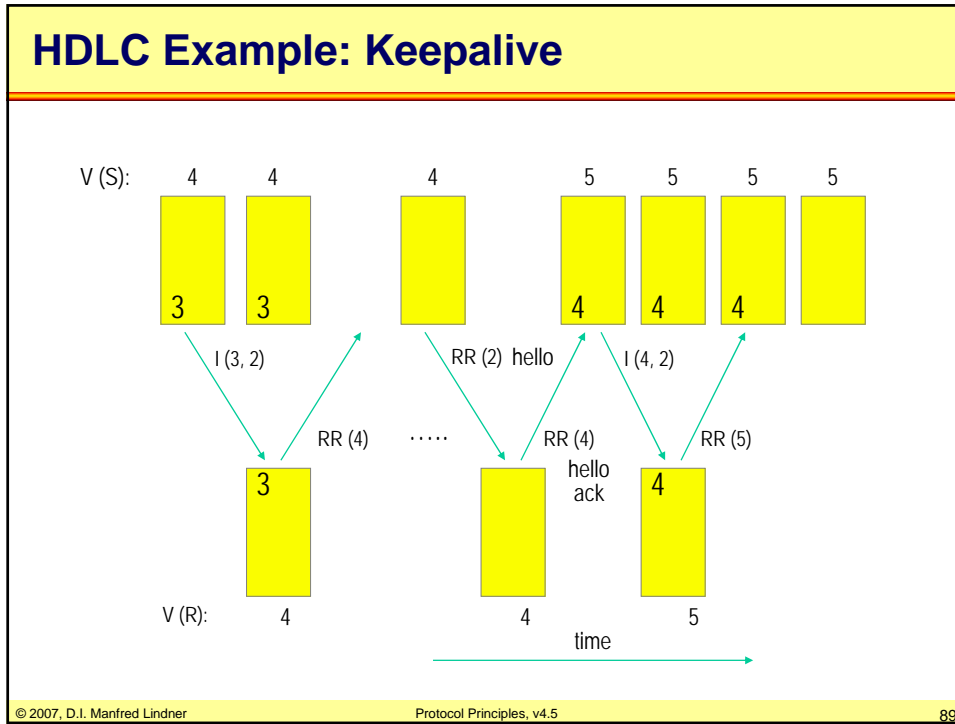

L02 - Protocol Principles

