

L03 - TDM Techniques (v6.0)

TDM Techniques

Time Division Multiplexing (synchronous, statistical)
Telco Backbones (Digital Voice Transmission, PDH, SDH)

L03 - TDM Techniques (v6.0)

Agenda

- Introduction
- **Synchronous (Deterministic) TDM**
- **Asynchronous (Statistical) TDM**
- **Telco Backbones**
 - Digital Voice Transmission
 - PDH
 - SDH

L03 - TDM Techniques (v6.0)**Introduction**

- **Line protocol techniques**
 - Were developed for communication between two devices over one physical point-to-point link
 - Bandwidth of physical link is exclusively used by the two stations
- **In case multiple communication channels are necessary between two locations**
 - Multiple physical point-to-point links are needed
 - Every point-to-point link is operated by line protocol techniques
 - SDM (Space Division Multiplexing)
 - Expensive solution
- **One method to use one physical link for multiple channels is**
 - TDM (Time Division Multiplexing)
 - Note: FDM, DWDM, CDM are other methods

In this chapter we will discuss Time Division Multiplexing (TDM) techniques which is the most common transport technology used today.

Nevertheless there are also some alternative multiplexing techniques available like:

- Space Division Multiplexing (SDM) - data is sent across physically separated media
- Frequency Division Multiplexing (FDM) – uses different electrical frequencies to transport data on one and the same physical media
- Dense Wavelength Division Multiplexing (DWDM) – mainly used in fiber optic systems, data is transported on separate wavelengths of light
- Code Division Multiplexing (CDM) – data is transported (and differentiated) by different types of code

TDM can be used in a deterministic way which means dedicated bandwidth and dedicated delay (synchronous TDM) or in a statistical manner shared bandwidth and variable delay (asynchronous TDM).

Deterministic TDM has constant delay and bandwidth for a given individual communication channel and is used in techniques like ISDN, PDH or SDH.

Statistical TDM has variable delay and bandwidth for a given individual communication channel and is used in technologies like X25, Frame-relay, ATM or IP.

L03 - TDM Techniques (v6.0)

TDM Multiplexing / Demultiplexing

- **TDM multiplexer**

- Take a number of input channels and - by interleaving them - output them as one data stream on one physical **trunk** line
- Demultiplexer does the opposite

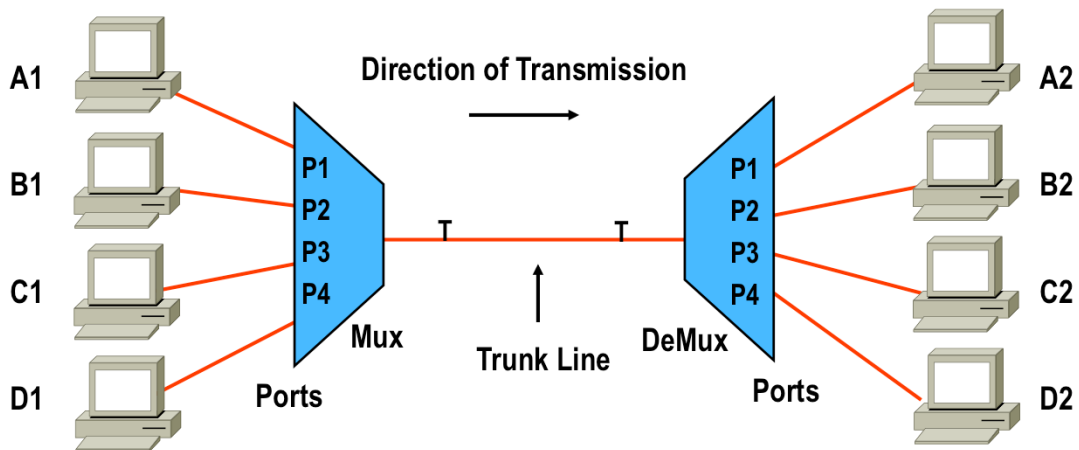

© 2016, D.I. Lindner / D.I. Haas

TDM Techniques, v6.0

5

Time division multiplexer allocates each input channel a period of time or timeslot and controls bandwidth of trunk line among input channels

Individual time slots are assembled into frames to form a single high-speed digital data stream. The available transmission capacity of the trunk is time shared between various channels. At the destination a demultiplexer reconstructs individual channel data streams.

L03 - TDM Techniques (v6.0)**Types of TDM**

- **Depending on timing behavior two basic TDM methods**
 - Synchronous (deterministic) TDM
 - Timeslots have constant length (capacity) and can be used in a synchronous, periodical manner
 - Examples: PDH (E1, T1), SDH (STM-1, STM-4), ISDN
 - Asynchronous (statistical) TDM
 - Timeslots have variable length and are used on demand (depending on the statistics of the individual channel communication)
 - Examples: X.25, Frame-Relay, ATM, IP, Ethernet, WLAN ...

Synchronous TDM framing on the trunk line can be vendor dependent which was used by proprietary TDM products or can be standard based.

Two main architectures for standard based synchronous TDM on trunk lines for carrying PCM-coded digital telephony were established in the past:

PDH - Plesiochronous Digital Hierarchy developed in the 1960s (e.g. E1 (2Mbit/s), E3 (34Mbit/s), E4, T1 (1,544Mbit/s), T3)

SDH - Synchronous Digital Hierarchy developed in the 1980s (e.g. STM-1 (155Mbit/s), STM-4 (622Mbit/s), STM-16)

L03 - TDM Techniques (v6.0)

Agenda

- Introduction
- Synchronous (Deterministic) TDM
- Asynchronous (Statistical) TDM
- Telco Backbones
 - Digital Voice Transmission
 - PDH
 - SDH

L03 - TDM Techniques (v5.2)

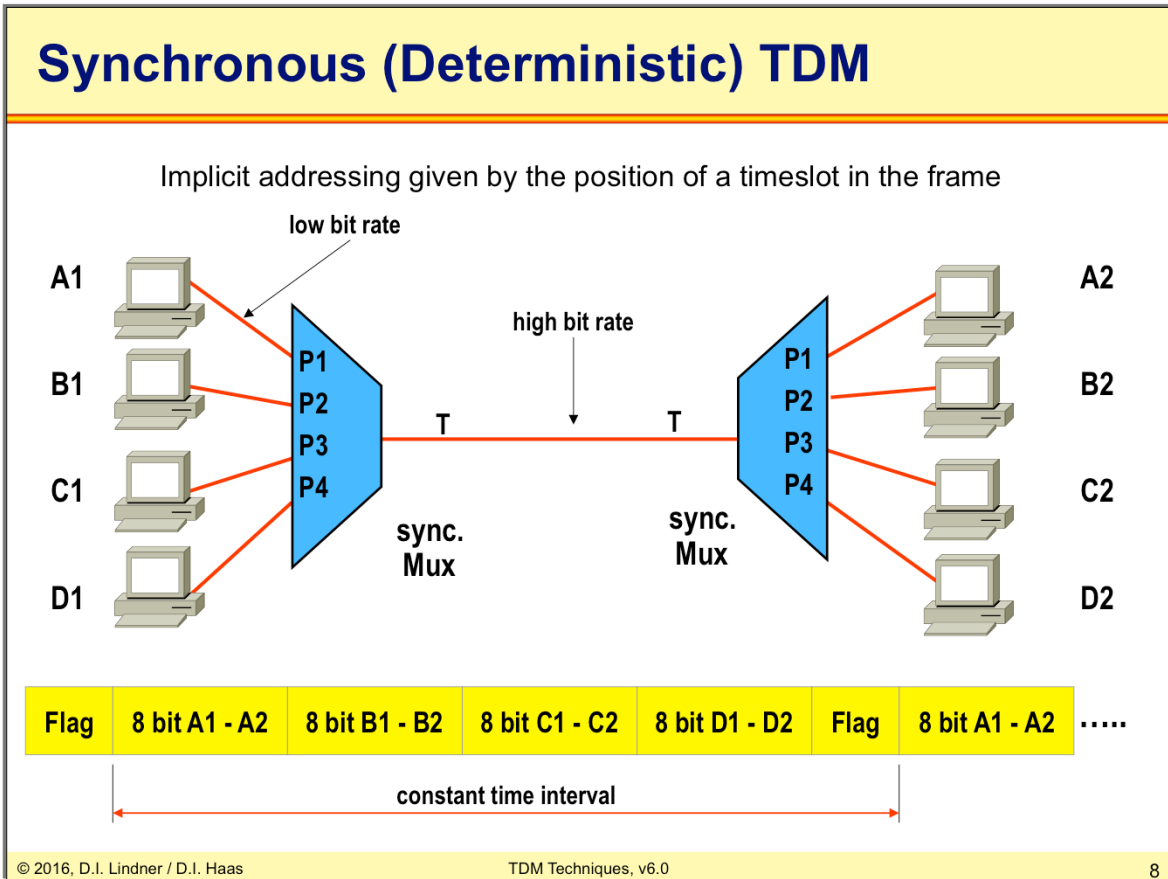

Synchronous TDM periodically generates a frame consisting of a constant number of timeslots each timeslot of constant length. A starting delimiter (Flag) is used for frame synchronization, which is needed to differentiate one frame from the next frame. Because of the Flag the individual timeslots can be identified by position within a frame (timeslot 1, timeslot 2, and so on).

In our example we have four timeslots 1 – 4. Every input channel is assigned a dedicated timeslot e.g. data of port P1 will be carried in timeslot 1 for the A1 to A2 communication, data of port P2 will be carried in timeslot 2 for the B1 to B2 communication and so on. In our example we use “Byte-interleaving” that means a single timeslot carries 8 bit of the corresponding channel per frame.

L03 - TDM Techniques (v6.0)

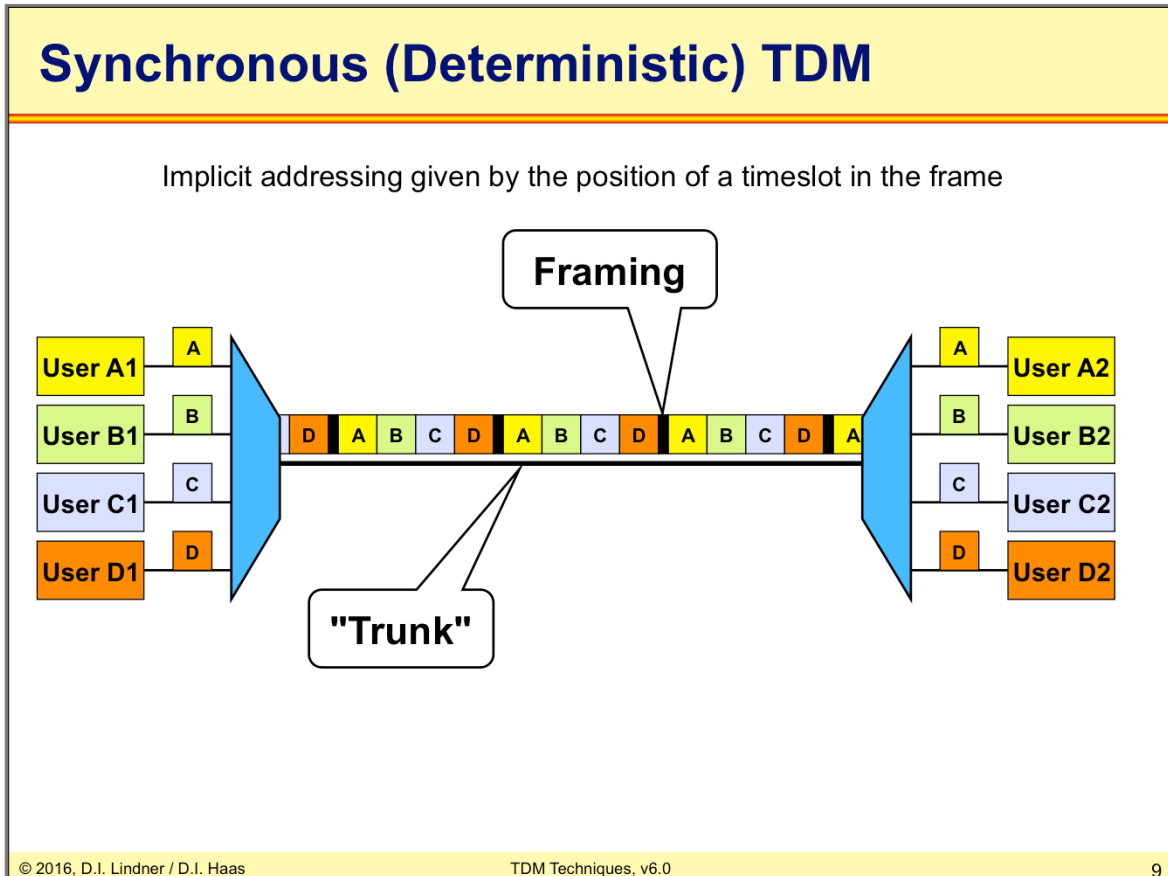

Deterministic TDM systems use transport frames like E1, T1 (PDH), STM1 (SDH), etc in which the actual data can be filled in transparently. The framing is needed for synchronization, network management and sometimes error detection functions between multiplexer and demultiplexer devices.

Each communication channel on a deterministic TDM connection is identified by its timely position inside the TDM frame. Principally no further headers or address information is required by the payload.

L03 - TDM Techniques (v6.0)

Trunk Speed with Synchronous TDM

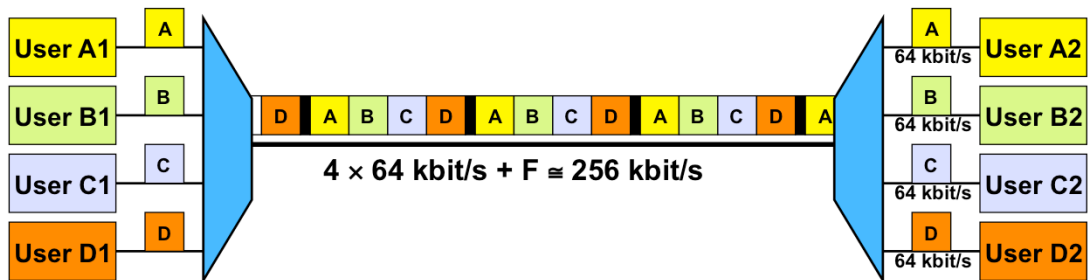

- **Trunk speed = Number of slots × User access rate**
- **Each user gets a constant timeslot of the trunk**

The bandwidth needed on a deterministic TDM trunk is always determined by the sum of all communication channels on the trunk plus some administrative overhead, because of the fixed correlation between communication channel and timeslot.

In our example we find four communication channels with a capacity of 64Kbits/s each, so the transport capacity of the trunk needs to be 256 Kbits/s.

L03 - TDM Techniques (v6.0)

Idle Timeslots with Synchronous TDM

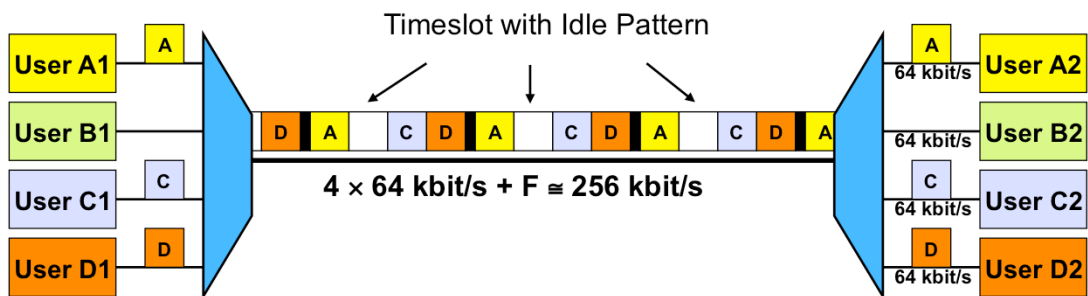

- If a communication channel has nothing to transmit
- -> Idle timeslots -> Waste of bandwidth

The major disadvantage of deterministic TDM systems is the fixed correlation between communication channel and time slot position. This means if one communication channel is not used it still occupies the time slot capacity by sending some kind of idle pattern.

L03 - TDM Techniques (v6.0)

Deterministic TDM - Advantages

- **Compared to pure point-to-point physical links**
 - Synchronous multiplexing adds only minimal delays
 - Time necessary to packetize and depacketize a byte
 - Transmission/propagation delay on trunk
- **The end-to-end delay for transporting a byte is constant**
- **The time between two bytes to be transported is constant**
 - Hence optimal for isochronous transmission requirements like traditional digital voice
- **Any line protocol could be used between devices**
 - Method is protocol-transparent
- **To endsystems**
 - Channel looks like a single physical point-to-point line

L03 - TDM Techniques (v6.0)

Deterministic TDM - Disadvantages

- **Bitrate on trunk line T**
 - Sum of all port bitrates (P1-P4) plus frame synchronization (flag)
 - High bitrate is required
 - Hence expensive
- **If no data is to be sent on a channel**
 - Special idle pattern will be inserted by the multiplexer in that particular timeslot
 - Waste of bandwidth of trunk line
- **Asynchronous (statistic) TDM avoids both disadvantages by**
 - Making use of communication statistics between devices

Summary: Synchronous TDM (1)

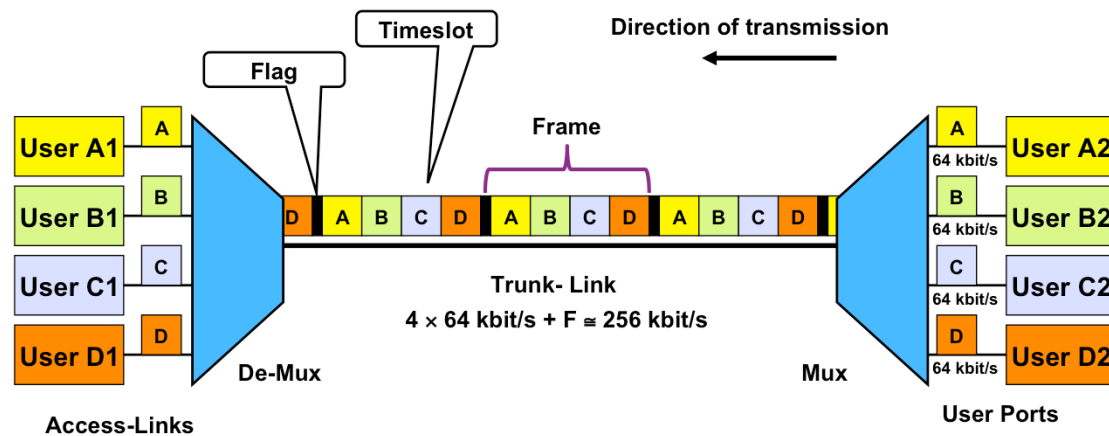

Access-Links

Periodic frames consisting of a constant number of timeslots
 Every channel occupies a dedicated timeslot
 Implicit addressing given by the position of a timeslot in the frame
 Trunk rate = number of timeslots x access-link rate

Each channel experiences constant delay and no delay variation (jitter)

© 2016, D.I. Lindner / D.I. Haas

TDM Techniques, v6.0

14

Synchronous TDM periodically generates a frame consisting of a constant number of timeslots - each timeslot of constant length. A starting delimiter (Flag) is used for frame synchronization, which is needed to differentiate one frame from the next frame. The bandwidth needed on a deterministic TDM trunk is always determined by the sum of all communication channels on the trunk plus some administrative overhead, because of the fixed correlation between communication channel and timeslot.

In our example we find four communication channels with a capacity of 64Kbits/s each, so the transport capacity of the trunk needs to be 256 Kbits/s.

Compared to pure point-to-point physical link synchronous multiplexing adds only minimal delays: Time necessary to packetize and depacketize a byte and transmission/propagation delay on the trunk.

The end-to-end delay for transporting a byte is constant and the time between two bytes to be transported is constant, hence optimal for isochronous transmission requirements like traditional digital voice.

Summary: Synchronous TDM (2)

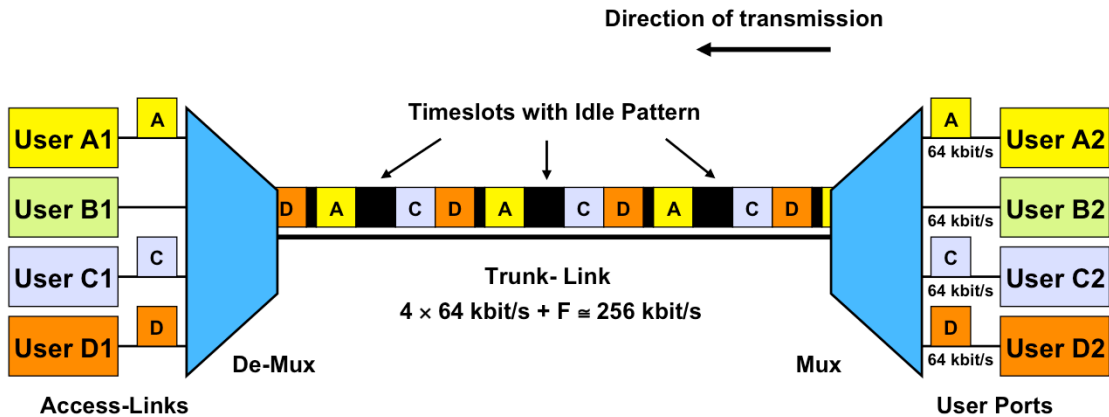

Timeslot can be used for any kind of communication

-> protocol transparency

But empty timeslots are not useable by other communication channels

-> waste of bandwidth during times of inactivity

Lead to development of asynchronous/statistical multiplexing

Any line protocol could be used between devices, method is protocol-transparent. For endsystems such a channel looks like a single physical point-to-point line.

The major disadvantage of deterministic TDM systems is the fixed correlation between communication channel and time slot position. This means if one communication channel is not used it still occupies the time slot capacity by sending some kind of idle pattern. Bad trunk utilization could occur if only a few of the reserved timeslots are in use. That leads to development of asynchronous / statistical TDM.

In synchronous (deterministic) TDM systems the order of the data packets is maintained, no packet overtake or time slot position change is possible. The frames need to have always the same size because the timeslots in deterministic TDM systems have a constant length.

Address information is not required, because the destination is determined by the time slot position.

Deterministic TDM is connection-oriented because a point to point connection is typically setup by usage of SC (switched circuit) techniques like ISDN or permanently established by usage of PC (permanent circuit = leased line) techniques like PDH/SDH.

Buffers are not needed because the data stream is sent out with exactly the same speed as it is received.

L03 - TDM Techniques (v6.0)

Agenda

- **Introduction**
- **Synchronous (Deterministic) TDM**
- **Asynchronous (Statistical) TDM**
- **Telco Backbones**
 - Digital Voice Transmission
 - PDH
 - SDH

L03 - TDM Techniques (v6.0)

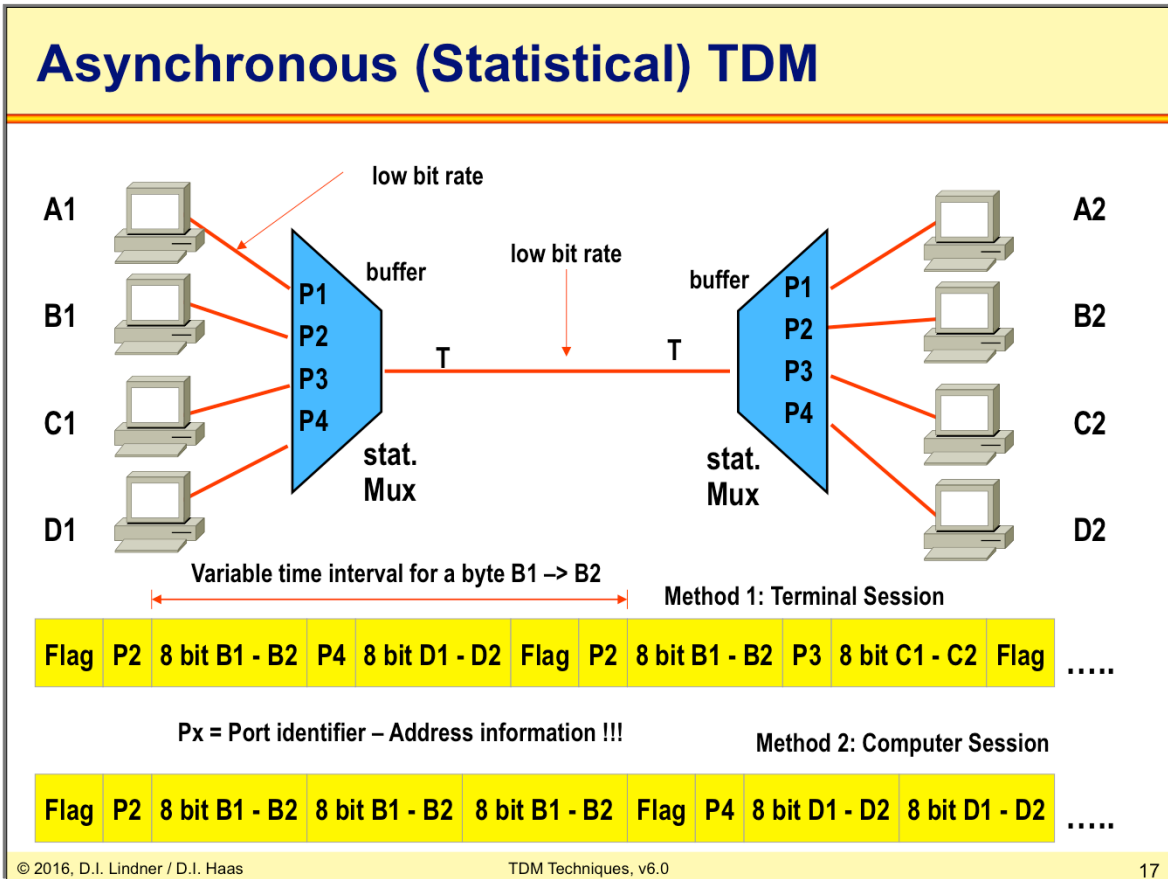

Usually computer devices communicate in a statistical manner because not all devices have data to transmit at the same time. Therefore it is sufficient to calculate necessary bitrate of the multiplexer trunk line according to the average bitrates caused by device communication. But if devices transmit simultaneously only one channel can occupy trunk line at a given time. Data of other channels must be buffered inside the multiplexer until trunk is available again (store and forward principle). Hopefully statistics is such that the trunk will not be monopolized by just a single channel. Otherwise a buffer overflow will occur in the multiplexer, leading to transmission errors seen by the individual channels.

Operation principle of asynchronous TDM:

Multiplexer generates a transmission frame only if data octets are present at input ports. The source of data must be explicitly identified in transmission frames so we need addressing because there exists no constant relationship between timeslot and channel as in synchronous TDM. In our example we use a port identifier as address information and sent it across the trunk.

The first method is to sample all the ports for waiting data bytes but taking only one byte from every channel for a transmission frame. This was used by character-oriented terminal networks (networks for connecting terminals to the host computer). People entering data at a terminal do it in a statistical manner, therefore a synchronous line is not really necessary.

The second method is to take all waiting data bytes of a single port for generation of a transmission frame. This was developed for computer-to-computer communication which also shows some statistics in their usual style of sending data bursts with waiting periods in between.

The later method became the base for all today's data communication -> packet switching (store and forward).

In case of congestion buffering helps but causes additional delays compared to synchronous TDM. Delays are variable because of statistical behavior hence not optimal for synchronous transmission requirements like traditional digital voice but still sufficient for transmission requirements like bursty data transfer between computers.

L03 - TDM Techniques (v6.0)

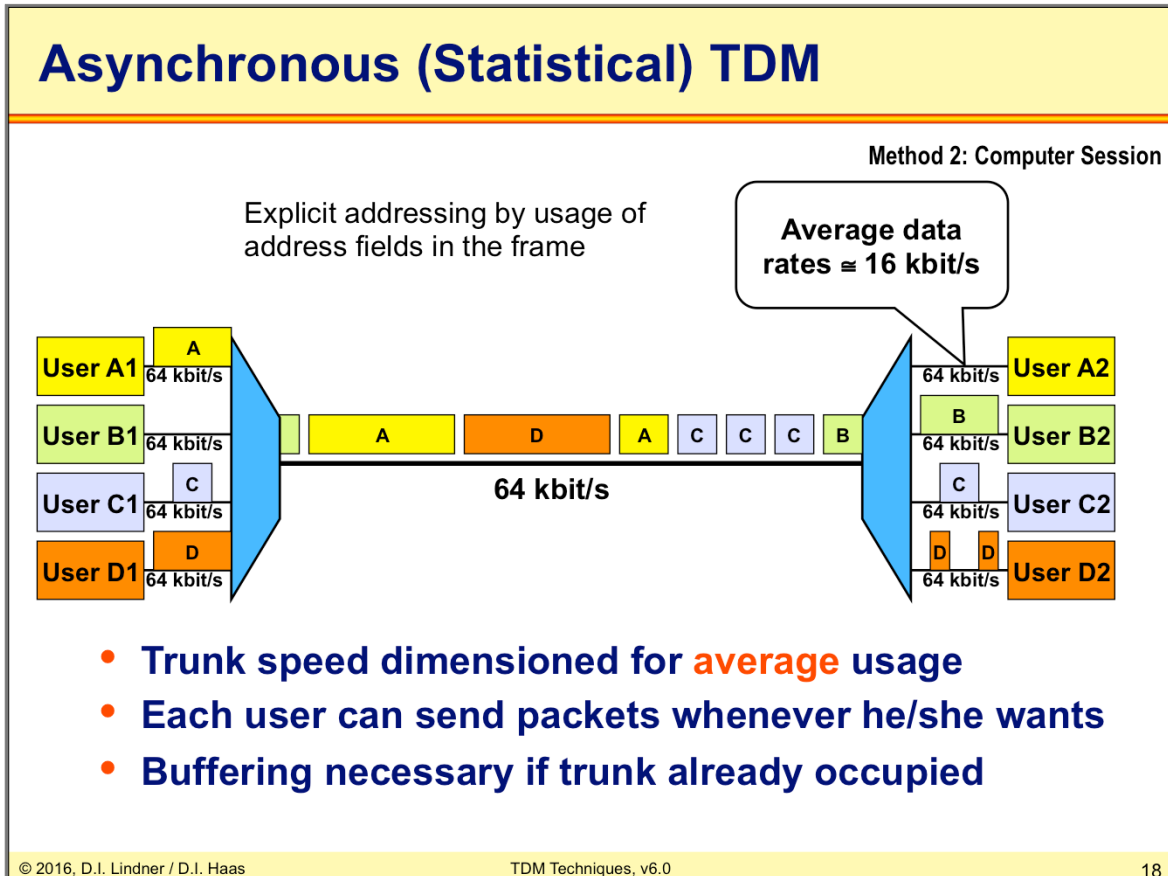

In statistical TDM systems there is no fixed correlation between timeslot position and communication channel as it is with deterministic TDM systems. Therefore the speed of the trunk could be chosen according to the average statistical transport needs of the users. Any user is allowed to send data at any time. Of course a separate addressing and framing scheme needs to be used because the fixed correlation between timeslot position and destination is broken in these systems.

L03 - TDM Techniques (v6.0)

Asynchronous (Statistical) TDM

Method 2: Computer Session

64 kbit/s

- **If other users are silent, one user can fully utilize his/her access rate**

© 2016, D.I. Lindner / D.I. Haas TDM Techniques, v6.0 19

One of the major advantages of statistical TDM systems compared to deterministic TDM systems is the following fact: if the trunk is empty one user may use the complete transport capacity of the trunk. On the other hand it may occur that all users want to use the trunk at the same time. Because of the statistical dimensioning of the trunk capacity it may happen that more data is fed in by the users than the trunk capacity allows. For such cases buffers are needed by the statistical TDM devices to compensate the speed differences. In case of buffer overflow conditions it may even happen that data is lost.

L03 - TDM Techniques (v6.0)

Asynchronous (Statistical) TDM Facts

- **Good utilization of trunk**
 - Statistically dimensioned
- **Frames can have different size**
- **Multiplexers require buffers**
- **Variable delays**
- **Address information required**
- **Usually not protocol transparent**
 - If protocol transparent buffer overflow would cause FCS error handled by the overlaying line protocol
 - Better to speak a protocol with flow control abilities between end system and multiplexer
 - That is a new element in our story
 - Until now flow control only end-to-end explained

Statistical TDM can be used protocol transparent however in case of buffer overflow transmission errors will be seen by devices (FCS errors in the frame of the line protocol used by a channel). In order to avoid FCS errors a kind of **flow control between multiplexer and device (end system)** should be used which is a new element in data communication handled so far because this is different from flow control between end systems learned so far in module about line protocols.

Examples for such flow control methods are:

HW based flow control based on handshake signals (e.g. RTS, CTS)

SW based flow control (e.g. XON/XOFF)

Protocol based flow control such as known in connection oriented line protocols like HDLC (e.g. RR and RNR)

Summary: Asynchronous TDM (1)

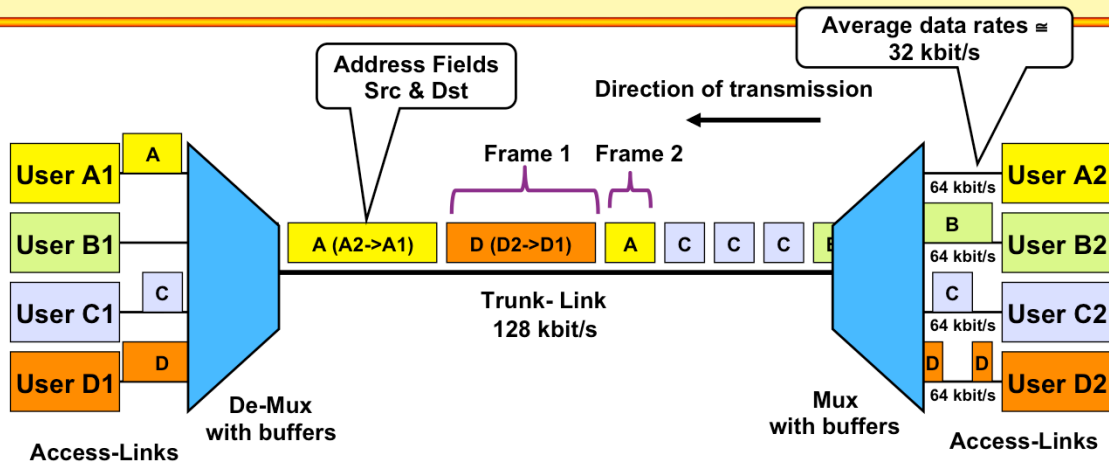

- Trunk rate is dimensioned for average usage in statistical manner
- Each user channels can send packets whenever he/she wants
- Frames have different lengths
- Buffering is necessary if trunk is already occupied by another channel
- Explicit addressing by usage of address fields in the frame
- Not protocol-transparent any more

Usually computer devices communicate in a statistical manner because not all devices have data to transmit at the same time. Therefore it is sufficient to calculate necessary bitrate of the multiplexer trunk line according to the average bitrates caused by device communication. The speed of the trunk could be chosen according to the average statistical transport needs of the users. Any user is allowed to send data at any time.

Now a asynchronous multiplexer generates a transmission frame only if data bytes are present at input ports. The source of data must be explicitly identified in transmission frames so we need addressing because there is no fixed correlation between timeslot position and communication channel as it is with deterministic TDM systems.

But if devices transmit simultaneously only one channel can occupy trunk line at a given time, data of other channels must be buffered inside the multiplexer until trunk is available again (store and forward principle). Hopefully statistics is such that the trunk will not be monopolized by just a single channel. Otherwise a buffer overflow will occur in the multiplexer, leading to transmission errors seen by the individual channels.

In case of congestion buffering helps but causes additional delays compared to synchronous TDM. Delays are variable because of statistical behavior hence not optimal for synchronous transmission requirements like traditional digital voice but still sufficient for transmission requirements like bursty data transfer between computers.

Summary: Asynchronous TDM (2)

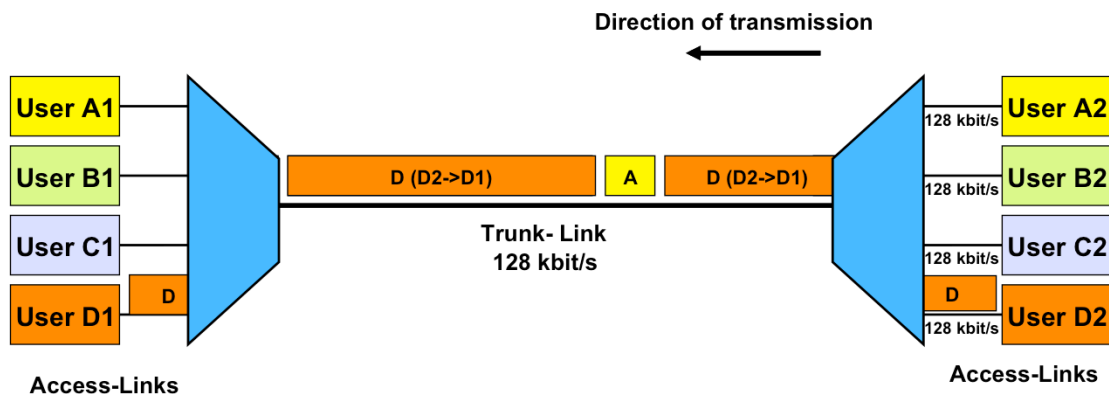

Access-Links

Access-Links

If other channels are silent, one channel can fully utilize his/her access rate
-> better usage of network bandwidth

Variable delay and variable delay variation (jitter)
Buffer overflow leads to loss of packets

One of the major advantages of statistical TDM systems compared to deterministic TDM systems is the following fact: if the trunk is empty one user may use the complete transport capacity of the trunk. On the other hand it may occur that all users want to use the trunk at the same time. Because of the statistical dimensioning of the trunk capacity it may happen that more data is fed in by the users than the trunk capacity allows. For such cases buffers are needed by the statistical TDM devices to compensate the speed differences. In case of buffer overflow conditions it may even happen that data is lost.

Statistical TDM allows a good utilization of the trunk because there is no waste of bandwidth by the use of idle patterns and the capacity is determined by the average needs of the users. The frame size may vary depending on the need of the users. Buffering is required under trunk overload conditions.

The delay is variable because of buffering.

Address information is needed because of the lost correlation between time slot position and destination.

Therefore statistical TDM is not protocol transparent because a separate packing as well as addresses are needed. End system and ADTM multiplexer have to speak the same protocol language.

L03 - TDM Techniques (v6.0)

Agenda

- **Introduction**
- **Synchronous (Deterministic) TDM**
- **Asynchronous (Statistical) TDM**
- **Telco Backbones**
 - Digital Voice Transmission
 - PDH
 - SDH

This chapter gives an introduction into the complex world of Telco technologies. First we discuss transmission basics related to voice and scalability issues.

In order to understand these technologies it is important to know about Shannon's laws, jitter problems, signal to noise problems, and digital hierarchy concepts.

After this basics sections this chapter presents two important Telco backbone technologies, PDH and SONET/SDH.

L03 - TDM Techniques (v6.0)

Telco Long History

- **Origins in late 19th century**

- **Voice** was/is the **yardstick**

- Same terms
- Same signaling principles
- Even today, although **data** traffic increases dramatically
- Led to technological constraints and demands

- **General Goals**

- **Interoperability**

- Over decades
- Over different vendors
- World-wide!

- **Availability**

- Protection lines in case of failures
- High non-blocking probability

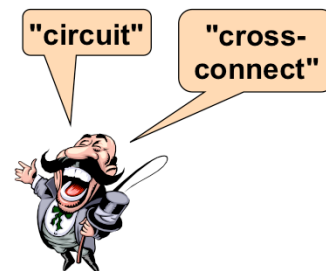

Telco technologies have a long history. Its origins date back until the late 19th century. Originally voice transmission was the only goal. Even today the characteristics of voice transmission forms the basic design of Telco technologies such as PDH and SONET/SDH.

The most important goals for Telco technologies are interoperability and availability.

Telco backbones are laid throughout nations and must therefore function over several decades, must integrate with older technologies and different vendors. Actually, people expect to communicate from any phone on earth to any other phone on earth.

Due to the big size of these networks even a small error probability can cause a denial of service for thousands or even millions of users. Because of this the Telco backbones must be designed to support great availability, for example using redundant protection lines which are activated in case of failures.

Additionally it cannot be economically justified to dimension a backbone connection which could support all possible users at the same time, for instance between two cities. Therefore the user behaviors must be estimated and complex statistical calculations are made in order to dimension the link.

L03 - TDM Techniques (v6.0)

Digital Voice – Synchronous TDM

- **Digital voice transmission**
 - Based on Nyquist-Shannon Theorem
 - Analogous voice can be digitized using pulse-code-modulation (PCM) technique requiring a 64kbit/s digital channel
 - Voice is sampled every 125usec (8000 times per second)
 - Every sample is encoded in 8 bits
 - Used up to now in the backbone of our telephone network
- **Synchronous TDM**
 - Originated from digital voice transmission by multiplexing of several 64kbit/s voice channels over a common trunk line

L03 - TDM Techniques (v6.0)

Sampling of Voice

- **Nyquist - Shannon Theorem**

- Any analogue signal with limited bandwidth f_B can be sampled and reconstructed properly when the sampling frequency is $2 \cdot f_B$
- Speech signal has most of its power and information between 0 and 4000 Hz
- Transmission of sampling pulses allows reconstruction of original analogous signal
- Sampling pulses are quantized resulting in binary code word which is actually transmitted

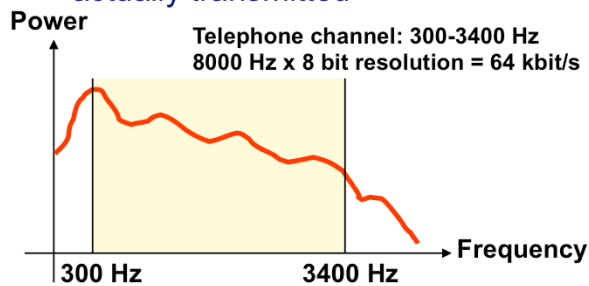

Compare it to the formula giving the maximum information-rate of a noiseless but bandwidth-limited line

$$R = 2 * B * \log_2 V$$

The Nyquist-Shannon sampling theorem requires that each bandwidth-limited signal must be sampled by a rate which is twice higher than the cut-off bandwidth of the signal in order to support an error-free (anti-aliased) reconstruction of the signal.

Since speech signals have most of their power below 4 kHz it has been agreed that speech is to be sampled 8000 times per second.

From this it follows that when each signal sample is encoded by one byte, a data rate of 64 kbit/s is necessary to transmit digital speech.

L03 - TDM Techniques (v6.0)

Linear Quantization

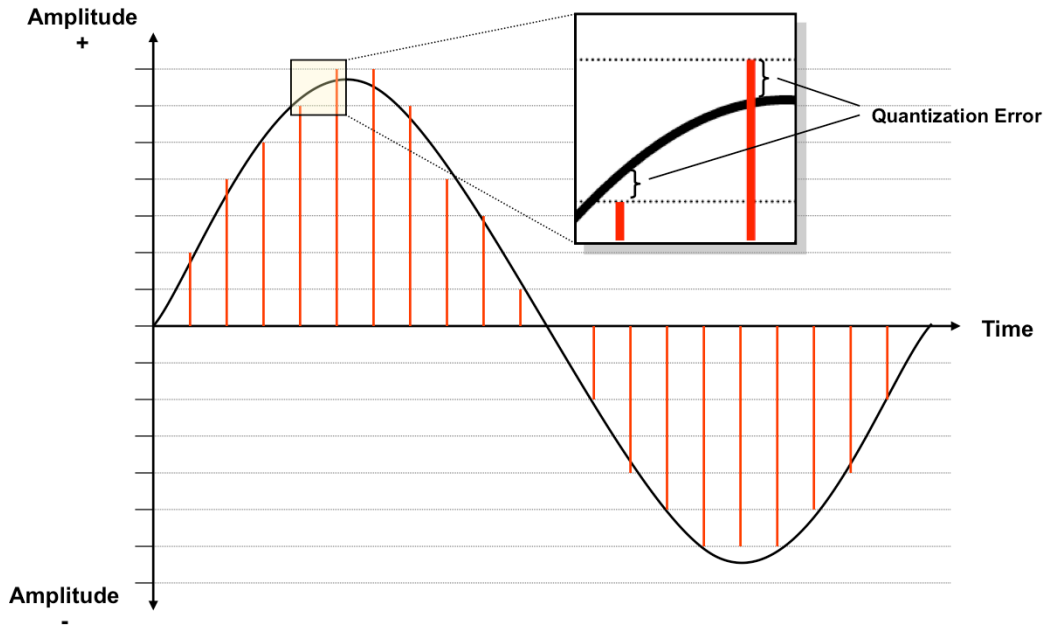

L03 - TDM Techniques (v6.0)

Improving SNR

- **SNR improvement of speech signals**
 - Quantize loud signals much coarser than quiet signals
 - Lower amplitudes receive a finer resolution than greater amplitudes
- **Expansion and compression specified by nonlinear function**
 - USA: μ -law (Bell)
 - Europe: A-law (CCITT)

Conversion is task of the μ -law world

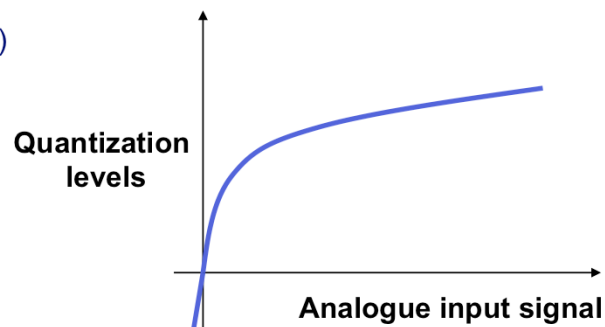

The Signal-to-Noise Ratio (SNR) is an indicator of signal quality. Furthermore, a better SNR allows lower signal strengths and higher data rates.

Digital voice is generally "compounded", that is the higher amplitude levels are quantized at a lower resolution and the smaller amplitudes at a higher quantization resolution. The characteristic of this compression and expansion technique is expressed by a nonlinear function which has first been defined by Graham Bell. In the USA the so-called μ -law is used while in Europe the CCITT defined the A-law function to improve the SNR.

Note that digital voice signals have to be converted when the μ -law world talks to the A-law world or vice versa. The rule is, that the conversion must be a task of the μ -law world.

L03 - TDM Techniques (v6.0)

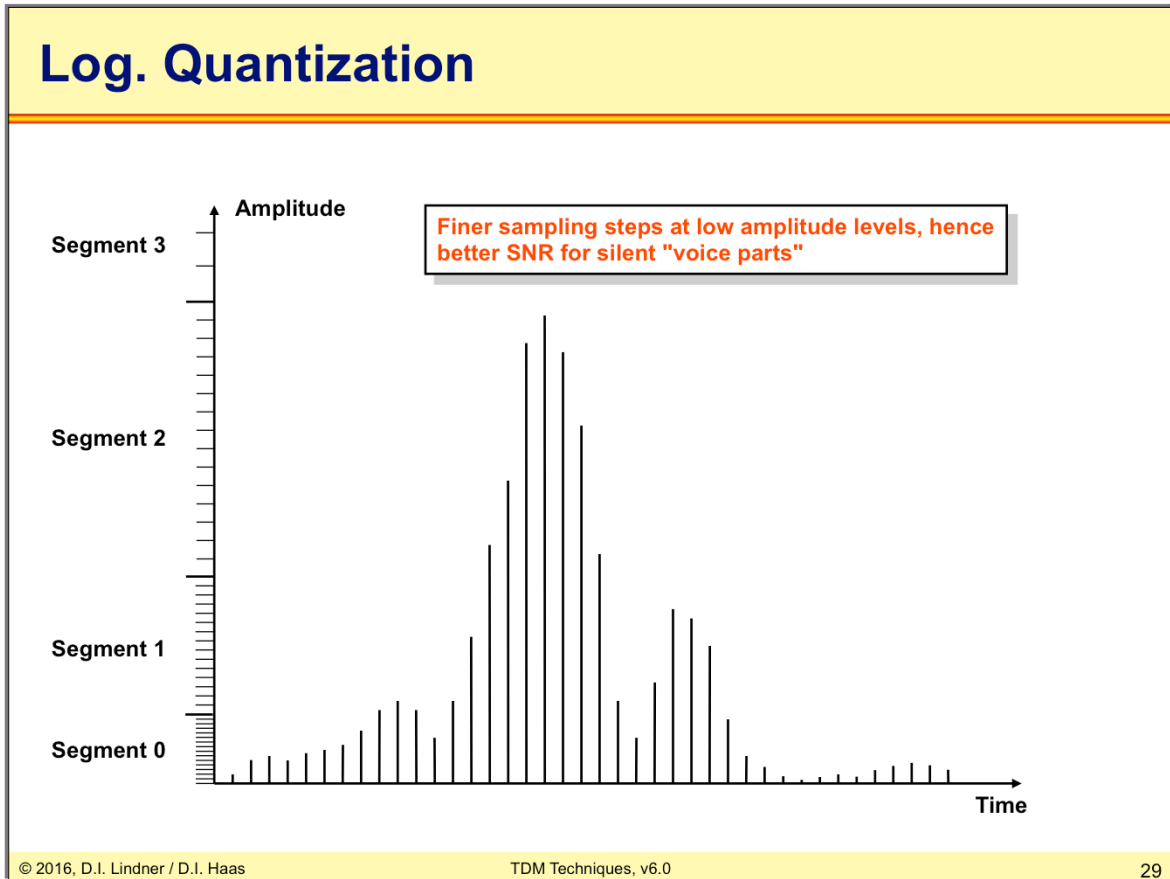

In order to achieve a good quality the signal-to-noise ratio (SNR) can be optimized when lower amplitudes receive a finer resolution than greater amplitudes.

L03 - TDM Techniques (v6.0)

Encoding (PCM)

- Putting digital values in a defined form for transmission

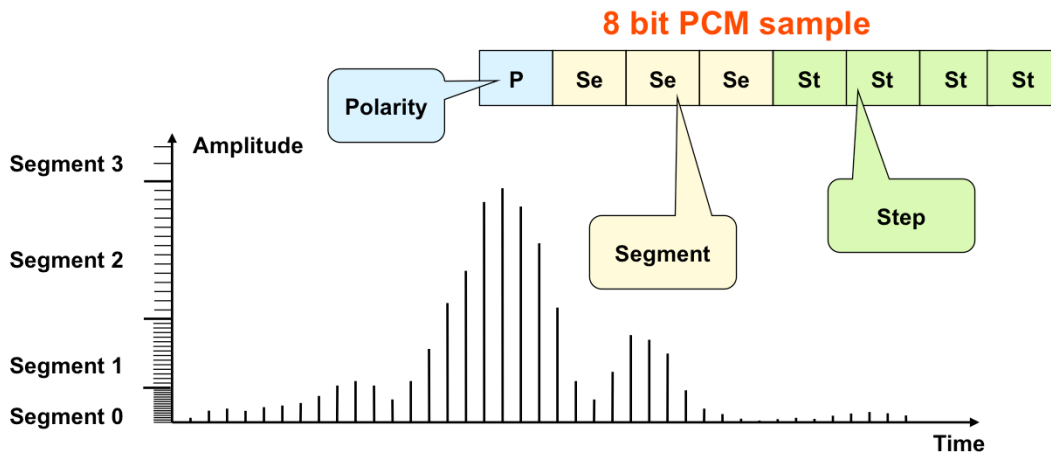

The most commonly used voice coding method is Pulse Code Modulation (PCM) where the analog signal is sampled at equal sample intervals (125 μ s or 8000 times per second) and quantized by an 8 bit resolution.

Three segment bits differentiate the signal into 8 segments for both positive and negative polarity. Each segment is in turn quantized by four bit, that is 16 amplitude steps. Note that the intervals are not equal in size, thus segment 0 detects small variations more precise than segment 1 or above. Segment 7 also has 16 amplitude steps but as this segment is the greatest, the analog signal is measured using a considerably coarse grid.

The most significant bit specifies the polarity of the signal.

L03 - TDM Techniques (v6.0)**Codec Standards**

- PCM
 - G.711 (64 kbps)
- ADPCM (Adaptive Differential Pulse Code Modulation)
 - Only the difference from one sample pulse to the next will be transmitted
 - Fewer bits used for encoding the difference value
 - G.726 (16, 24, 32, 40 kbps)
- LD-CELP (Low Delay Code Excited Linear Predictor)
 - G.728 (16 kbps)
- CS-ACELP (Conjugate Structure Algebraic CELP)
 - G.729 (8 kbps)
- Dual Rate Speech Coding Standard (G.723)
 - Uses minimal data rate of 5,3K (ACELP) at fair quality or 6,3K (MP-MPLQ) with good quality
- All above standards are used for VoIP
 - Voice transmission over IP networks
- GSM uses LCP (Linear Predictive Encoding)
 - 6,5 – 13 kbps

The slide above lists important ITU-T voice codec standards. Which codec should be used in practice? This decision depends on available bandwidth, required voice quality, and DSP utilization.

PCM requires 64 kbit/s but does not significantly burden the hardware. ADPCM also attempts to approximate the waveform using quantized samples but this codec only transmits the residual signal (the difference between the current amplitude and the amplitude of the previous sample).

LD-CELP compresses the voice signal by source coding methods. These methods are mathematically complex and burdens the DSPs.

If bandwidth is very narrow, then CS-ACELP is recommended. The G.729 standard provides good quality voice transmission over 8 kbit/s channels only. Typically a single DSP only supports a single CS-ACELP channel because of its complex algorithms necessary.

The enhanced standard G.729a provides nearly the same speech quality but uses an algorithm which reduces the algorithm complexity by 50%.

CNG = Comfort Noise Generator.

Note: GSM uses LPC (Linear Predictive Encoding) which allows compression between 6,5 and 13 kbit/s.

L03 - TDM Techniques (v6.0)**Isochronous Traffic vs. Realtime Traffic****• Isochronous Traffic**

- Data rate end-to-end must be constant
- Delay variation (jitter) is critical
 - To enable echo suppression
 - To reconstruct sampled analog signals without otherwise distortion

• Realtime Traffic

- Requires guaranteed bounded delay "only"
- Example:
 - Telephony (< 1s RTT)
 - Interactive traffic (remote operations)
 - Remote control
 - Telemetry

Next, it is important to understand the properties of isochronous traffic. "Iso" means "Equal" and "chronous" means "time". That is, each portion of data of an isochronous traffic must be delivered exactly with same delay.

Delay variations—also called "jitter"—are very critical for isochronous traffic. For example telephony requires isochronous transmission because of the bidirectional communication, echo suppression is necessary. But how to suppress echoes when they arrive at different times?

Realtime traffic does not necessarily require "fast" transmission. It only demands for "fast enough" transmission. That is, a bounded delay is defined within all required data must be received.

L03 - TDM Techniques (v6.0)

Solutions

- **Isochronous network**
 - Common clock for all components
 - Aka "**Synchronous**" network
- **Plesiochronous network**
 - With end-to-end synchronization somehow
- **Totally asynchronous network**
 - Using buffers (playback) and QoS techniques

There are several solutions to support telephony, which has both isochronous and realtime properties.

First, a total synchronous network can be created, utilizing a common clock for all network components.

Second, a plesiochronous network can be created, which is "nearly" synchronous but at least synchronized between end users.

Third, an asynchronous network can be used, such as the Internet or similar. Here it is very tricky to achieve end-to-end synchronization and bounded delays. Modern Quality of Service (QoS) techniques allow to overcome the asynchronous problems at least partly.

L03 - TDM Techniques (v6.0)

Agenda

- **Introduction**
- **Synchronous (Deterministic) TDM**
- **Asynchronous (Statistical) TDM**
- **Telco Backbones**
 - Digital Voice Transmission
 - PDH
 - SDH

L03 - TDM Techniques (v6.0)

Plesiochronous Digital Hierarchy

- **Created in the 1960s as successor of analog telephony infrastructure**
- **Smooth migration**
 - Adaptation of analog signaling methods
- **Based on Synchronous TDM**
- **Still important today**
 - Telephony access level
 - ISDN PRI
 - Leased line

In the middle of the 20th century, the telephony network infrastructure was still analog and very complex. Each connection was realized by a dedicated bundle of wires and all terminated in the central office. Signaling was slow and primitive and switching a time consuming process. Furthermore speech quality degraded on long haul connections.

In the 1960s digital backbones were created and also digital signaling protocols such as SS#7. Central office equipment became smaller and more efficient and the number of wires were reduced drastically. This technology was called Plesiochronous Digital Hierarchy (PDH) and is based on synchronous TDM, however it was not fully synchronous because of technical restrictions of that days.

PDH is still important and used today.

L03 - TDM Techniques (v6.0)

Why Plesiochronous?

- **1960s technology: No buffering of frames at high speeds possible**
- **Goal: Fast delivery, very short delays (voice!)**
 - Immediate forwarding of bits
 - Pulse stuffing instead of buffering
- **Plesiochronous = "nearly synchronous"**
 - Network is not synchronized but fast
 - Sufficient to synchronize sender and receiver

What exactly does "plesiochronous" mean? First it was clear that a digital backbone must be able to concentrate at least hundreds (or even thousands) of telephone calls. Assuming a data rate of 64 kbit/s per call, the backbone rate would be more or less 30 Mbit/s or something.

In the 1960s it was nearly impossible to design hardware which is able to buffer frames at that rate. But how to compensate slightly different data rates? On the other hand, buffering introduced delays—but isochronous realtime traffic should be transported.

So ideally each bit is immediately forwarded by the network nodes without buffering. Bit rate differences were compensated by a so-called "pulse stuffing" technique, which is also sometimes called "bit stuffing". Using this method any node of the network can compensate phase drifts due to differences of the sending rate by inserting or removing single data bits of the stream.

Of course the lowest rates must be synchronized in order to obtain a correct signal.

L03 - TDM Techniques (v6.0)

Why Hierarchy?

- **Only a hierarchical digital multiplexing infrastructure**
 - Can connect millions of (low speed) customers across the city/country/world
- **Local infrastructure: Simple star**
- **Wide area infrastructure: Point-to-point trunks or ring topologies**
 - Grooming required

Now we know the meaning of the term "plesiochronous". But what is meant by the term "hierarchy" in this context? Obviously Telcos were supposed to supply millions of users with a dial tone. Which topology would be most efficient? Only star topology can efficiently cover whole villages, cities, and even countries. A star consists of many point-to-point connections: each spoke is connected to a hub. The hub is called the "Central Office" (CO) and the spokes are either telephones or multiplexers.

Traffic always concentrates to the hubs but is also distributed from the hubs. The hubs are interconnected by PDH trunks. Many trunks constitute spokes and are again concentrated in another—higher level—hub. This principle is applied recursively, forming a so-called Digital Hierarchy. If you go deeper into this hierarchy you will see higher data rates.

The backbone itself consists of point-to-point or ring topologies. Rings have the advantage of providing one redundant connection between each two nodes.

Of course the number of links are much lower in the heart of the hierarchy (therefore the data rate is much higher). Hubs are responsible to collect all user signals that are destined to the same direction and put them onto the same trunk. This process is called "grooming".

L03 - TDM Techniques (v6.0)

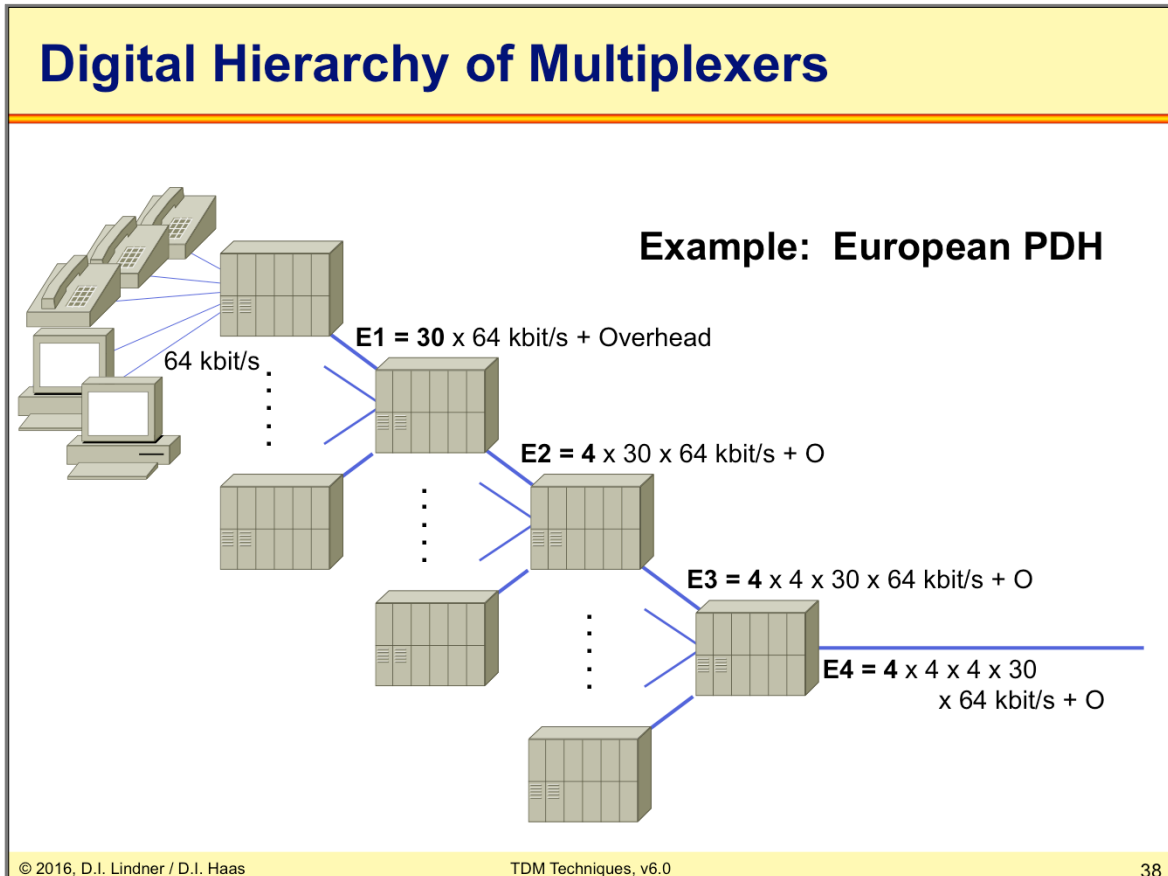

The picture above shows the digital multiplexing hierarchy used in European PDH networks. The lowest data rate uses so-called "E1" frames, consisting of 30 user signals. At each multiplexing level four lower rate channels can be combined to one higher rate channel. This way an "E2", "E3", and "E4" is formed.

Also higher multiplexing levels had been defined, for example "E5" but they are not used very often.

L03 - TDM Techniques (v6.0)

Digital Signal Levels

- **Differentiate:**
 - **Signal** (Framing layer)
 - **Carrier** (Physical Layer)
- **North America (ANSI)**
 - DS-n = Digital Signal level n
 - Carrier system: T1, T2, ...
- **Europe (CEPT)**
 - CEPT-n = ITU-T digital signal level n
 - Carrier system: E1, E2, ...

The Telco world differentiates between the digital signal level and the carrier system. The signal level can be regarded as the OSI link layer and the carrier system is similar to the OSI physical layer. Note that this picture is not really correct because the OSI system cannot really be applied to this world.

In North America the ANSI is responsible for Telco standardization efforts and defined the so-called Digital Signal DS to identify the framing layer. For example DS-0 is the 64 kbit/s user signal and DS-1 denotes the first multiplexing level.

Equivalently the carrier system for DS-1 is called T1, and DS-2 is carried upon T2, and so on.

The same thing happened in Europe. The Conference of European Post and Telecommunications (CEPT, now ETSI) defined signal levels CEPT-1, CEPT-2, and so on, to be carried upon E1, E2, etcetera.

L03 - TDM Techniques (v6.0)

Worldwide Digital Signal Levels

North America

Signal	Carrier	Channels	Mbit/s
DS0		1	0.064
DS1	T1	24	1.544
DS1C	T1C	48	3.152
DS2	T2	96	6.312
DS3	T3	672	44.736
DS4	T4	4032	274.176

Europe

Signal	Carrier	Channels	Mbit/s
DS0	"E0"	1	0.064
CEPT-1	E1	32	2.048
CEPT-2	E2	128	8.448
CEPT-3	E3	512	34.368
CEPT-4	E4	2048	139.264
CEPT-5	E5	8192	565.148

- **Incompatible MUX rates**
- **Different signaling schemes**
- **Different overhead**
- **μ -law versus A-law**

The tables above summaries the North American and the European PDH systems. These signal levels are related according to the following formulas:

ANSI T1.107 Hierarchy:

$$DS1C = 2 \times DS1$$

$$DS2 = 4 \times DS1$$

$$DS3 = 7 \times DS2$$

$$DS4/NA = 3 \times DS3 \text{ (international connections only)}$$

$$DS4 = 6 \times DS3 \text{ (rare)}$$

ITU-T Hierarchy:

$$E_{n+1} = 4 \times E_n$$

Later a harmonization of the ANSI and ITU-T hierarchy has been made. The ANSI international DS4/NA (not listed above) is compatible to the 139264 kbit/s E4.

The basic message of the slide above is that there are several inconsistencies between the two systems, including MUX rates, signaling schemes, overhead differences, and compounding methods.

L03 - TDM Techniques (v6.0)

Multiplexing Basics

DS0

8 bits of PCM sample

8 bits of next PCM sample

e.g. DS1/E1

time

125 μ sec = 1/8000 = 1 frame

“timeslots”

- **Frame rate is always 8000 frame per second at all levels of the hierarchy**
- **Byte interleaved multiplexing**

© 2016, D.I. Lindner / D.I. Haas

TDM Techniques, v6.0

41

DS0 = Digital Signal, Level 0 = 1 timeslot in multiplexing frames.

DS0 is the base for hierarchical digital communication systems equals one PCM coded voice channel with 64 kbit/s.

Each PCM samples (byte) must arrive within 125 μ s in order to receive 8000 samples (bytes) per second

Higher order frames must ensure the same byte-rate per user.

L03 - TDM Techniques (v6.0)

Multiplexing Basics

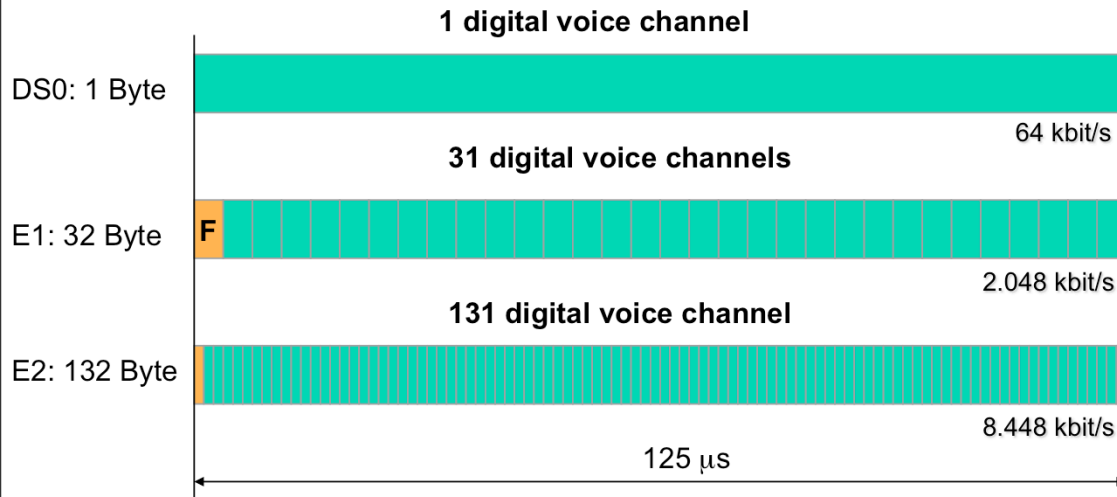

- note: DS0 and higher rates can be used for any transport digital information -> data transmission

Remember that voice transmission was and is the yardstick for Telco backbone technologies. Since all higher digital signal levels are basically multiplex methods to transport many DS0 signals it is clear that each multiplex frame (e.g. an E1 frame or E2 frame etc) must be transmitted within the same time period than the DS0 signal. A DS0 signal has 64 kbit/s which is created by sending one byte of a voice sample 8000 times per second.

As it can be seen in the picture above, each user—each DS0—is assigned to one timeslot in the higher rate frames. Moreover, there is exactly one byte for each user. Thus, in order to assure a proper delivery of the DS0 signal within a higher rate frame, any higher rate frame must be sent within 125 μ s, which is 1/8000.

We call this a "periodic frame".

L03 - TDM Techniques (v6.0)

Plesiochronous Multiplexing

- **Bit interleaving at higher MUX levels**
 - Simpler with slow circuits (Bit stuffing!)
 - Complex frame structures and multiplexers (e.g. M12, M13, M14)
- **DS1/E1 signals can only be accessed by demultiplexing**
- **Add-drop multiplexing not possible**
 - All channels must be demultiplexed and then recombined
 - No ring structures, only point-to-point

Since frequency shifts are compensated by bit stuffing it is not possible to implement byte interleaving multiplexers at higher rates. Therefore higher multiplex levels are bit-interleaved! This results in complex frame structures. For example a M12 multiplexer converts a four E1s into one E2, whereas a M14 multiplexer converts several E1 frames into one E4 frame.

Obviously, single DS1/E1 signals can only be accessed by demultiplexing the whole higher rate frame! Moreover, it is technically very difficult to implement add-drop multiplexers because DS1/E1 signals are needed by Digital Cross Connects (DXCs). The only way is to remove bit stuffing and do resynchronization.

L03 - TDM Techniques (v6.0)

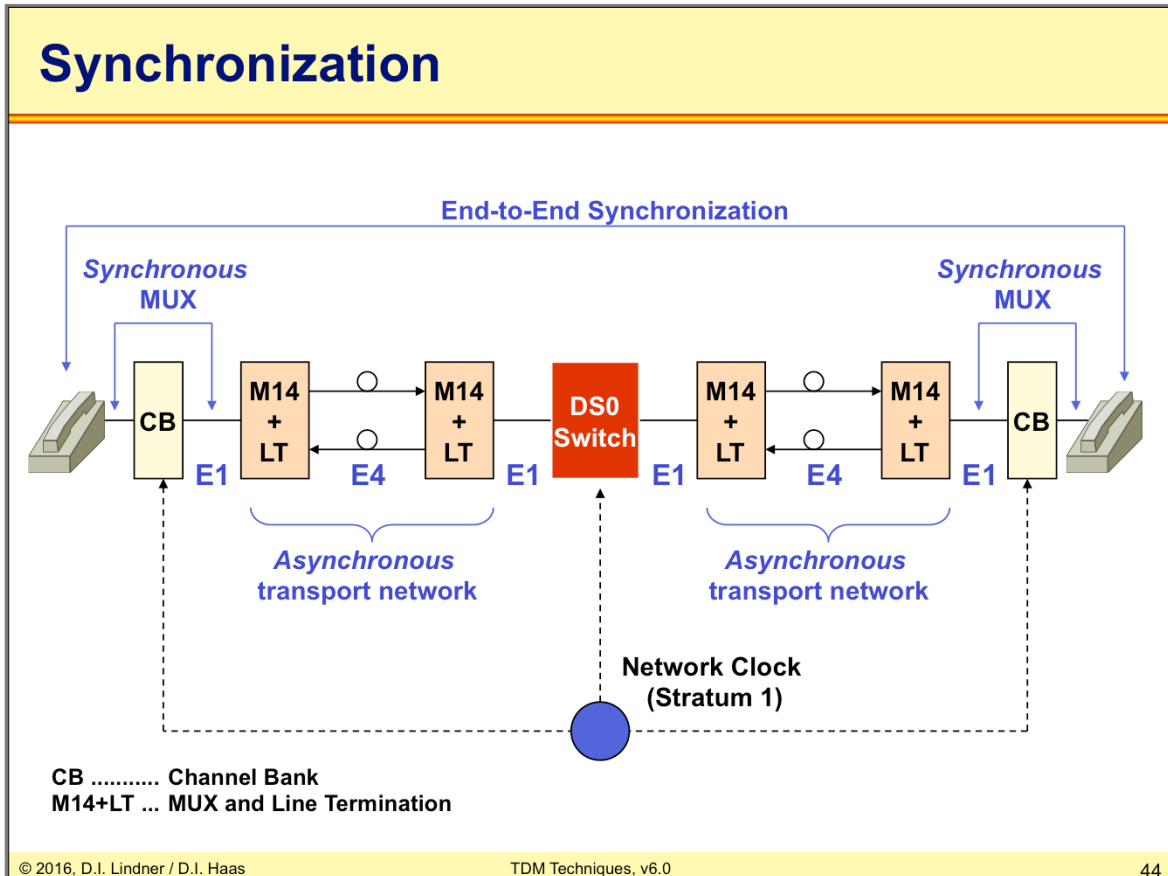

Clocks are not synchronized centrally because this was impractical at the time of the creation of this scheme—however, drift is inside specified limits.

Note that actually asynchronous TDM (!) is used at higher levels!

"Pulse stuffing" is used to compensate clock differences. Using pulse stuffing frequency shifts can be compensated as the total number of bits/frame might be increased or decreased to adjust the bits per second rate.

A so-called Stratum 1 clock is used to synchronize E1 frames. This is an atomic clock with a guaranteed accuracy of 10^{-11} (0.000001 ppm). Using independent Stratum 1 clocks would cause only one frame loss every 72.3 days. Stratum 1 clocks are typically only available in Central Offices because they are very expensive. Practically the timing signal is embedded inside dedicated E1 channels to supply branch offices (timing distribution).

Higher rate signals are asynchronous with respect to the transported E1 signals.

L03 - TDM Techniques (v6.0)**E1 Basics**

- **CEPT standardized E1 as part of European channelized framing structure for PCM transmission (PDH)**
 - E1 (2 Mbit/s)
 - E2 (8 Mbit/s)
 - E3 (34Mbit/s)
 - E4 (139Mbit/s)

- **Relevant standards**
 - G.703: Interfacing and encoding
 - G.704: Framing
 - G.732: Multiplex issues

G.703 specifies electrical and physical characteristics such as 75 ohm coax cables (unbalanced) or 120 ohm twisted pair (balanced), and the HDB3 encoding.

G.704 specifies framing structures for different interface rates. For example E1 is used at an interface rate of 2.048Mbit/s and uses 32 timeslots (8 bit each) per frame. The frame repetition rate is always 8000 Hz, therefore $32 \times 8 \times 8000 = 2.048$ Mbit/s. Also reserved E1 timeslots are defined: Timeslot 0 is used for frame synchronization and allows distinction of frames and timeslots; timeslot 16 can be used for signaling.

G.732 specifies the PCM multiplex equipment operating at 2.048 Mbit/s. This frames use the structure defined in G.704. Furthermore A-law must be used when converting analog to digital. G.732 also describes loss and recovery of frame alignment, fault conditions and consequent actions, and acceptable jitter levels.

L03 - TDM Techniques (v6.0)

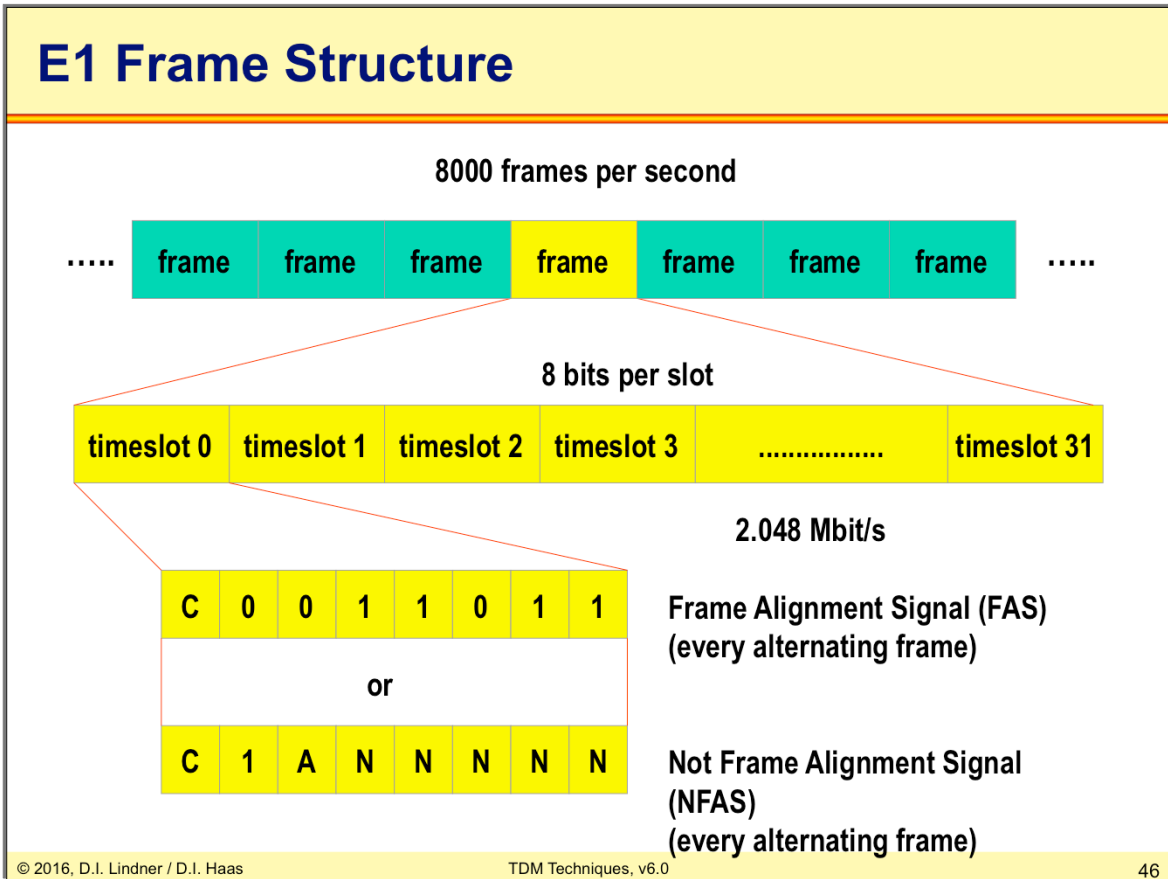

The timeslot 0 is used for frame checking and multiframe synchronization—end-to-end!
 Every second frame timeslot 0 contains FAS used for frame synchronization.
 The C (CRC) bit is part of timeslot 0 and can form an optional 4-bit CRC sequence using 4 consecutive E1 frames. The A (Alarm Indication) bit can transmit a so called "Yellow" alarm (remote error) to signal loss of signal (LOS) or out of frame (OOF) condition to the remote station.
 N (National) bits are vendor specific and reserved.

L03 - TDM Techniques (v6.0)

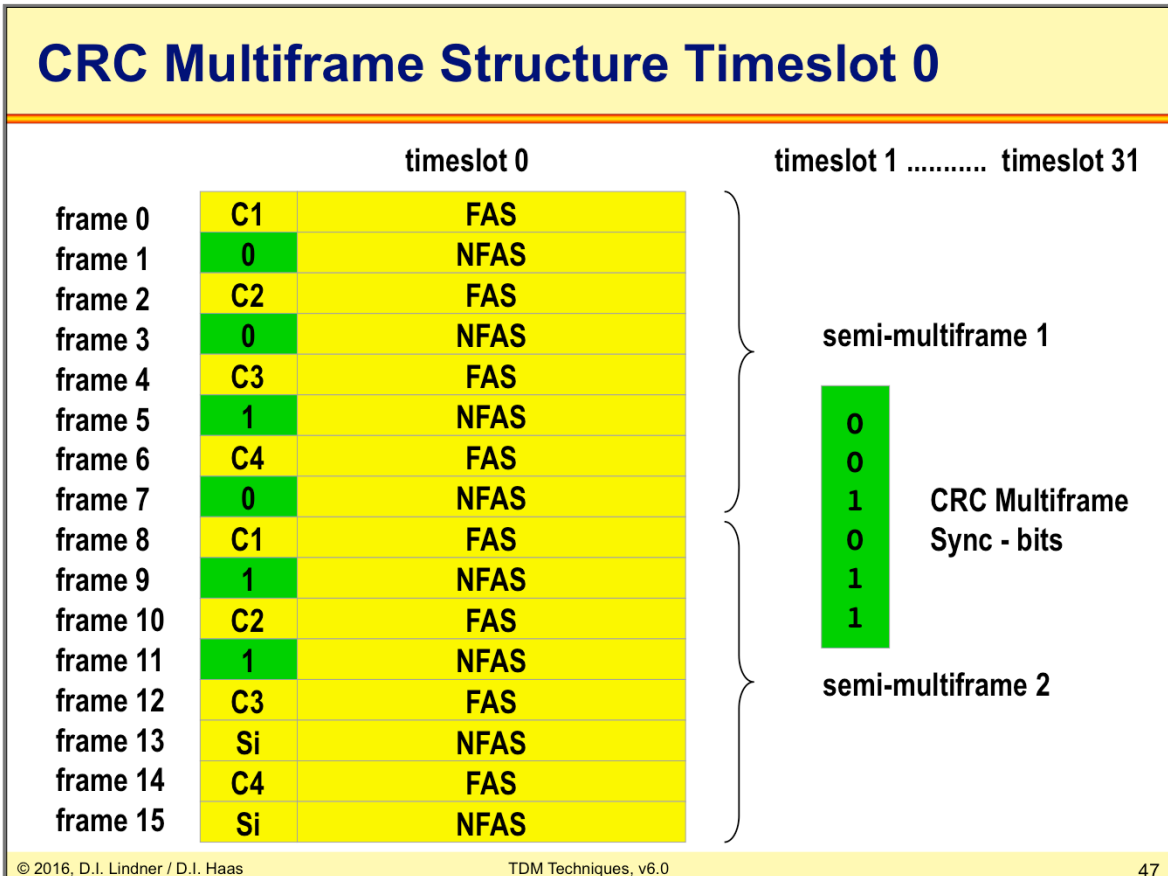

A so-called "multiframe structure" consists of 16 consecutive frames and are regarded as two-dimensional arrays.

A multiframe consists of two "semi-multiframes", whereas semi-multiframe 2 contains 4 CRC bits that protect semimultiframe 1

The Si bits are used to report CRC errors to the remote station

L03 - TDM Techniques (v6.0)

E1 Signaling: Timeslot 16

- **To connect PBXs via E1**
 - Timeslot 16 can be used as **standard** out-band signaling method
- **Common Channel Signaling (CCS)**
 - Dedicated 64 kbit/s channel for signaling protocols such as DPNSS, CorNet, QSIG, or SS7
- **Channel Associated Signaling (CAS)**
 - 4 bit signaling information per timeslot (=user) every 16th frame
 - 30 independent signaling channels (2kbit/s per channel)

The timeslot 16 can be used for so-called Channel Associated Signalling (CAS), a classical method to carry outband signaling information for all 30 user channels. This method is typically used to interconnect two PBXs of different vendors.

More efficient is to run a dedicated higher-level signaling protocol over timeslot 16, such as SS7 or QSIG. This method is generally known as Common Channel Signaling (CCS).

L03 - TDM Techniques (v6.0)

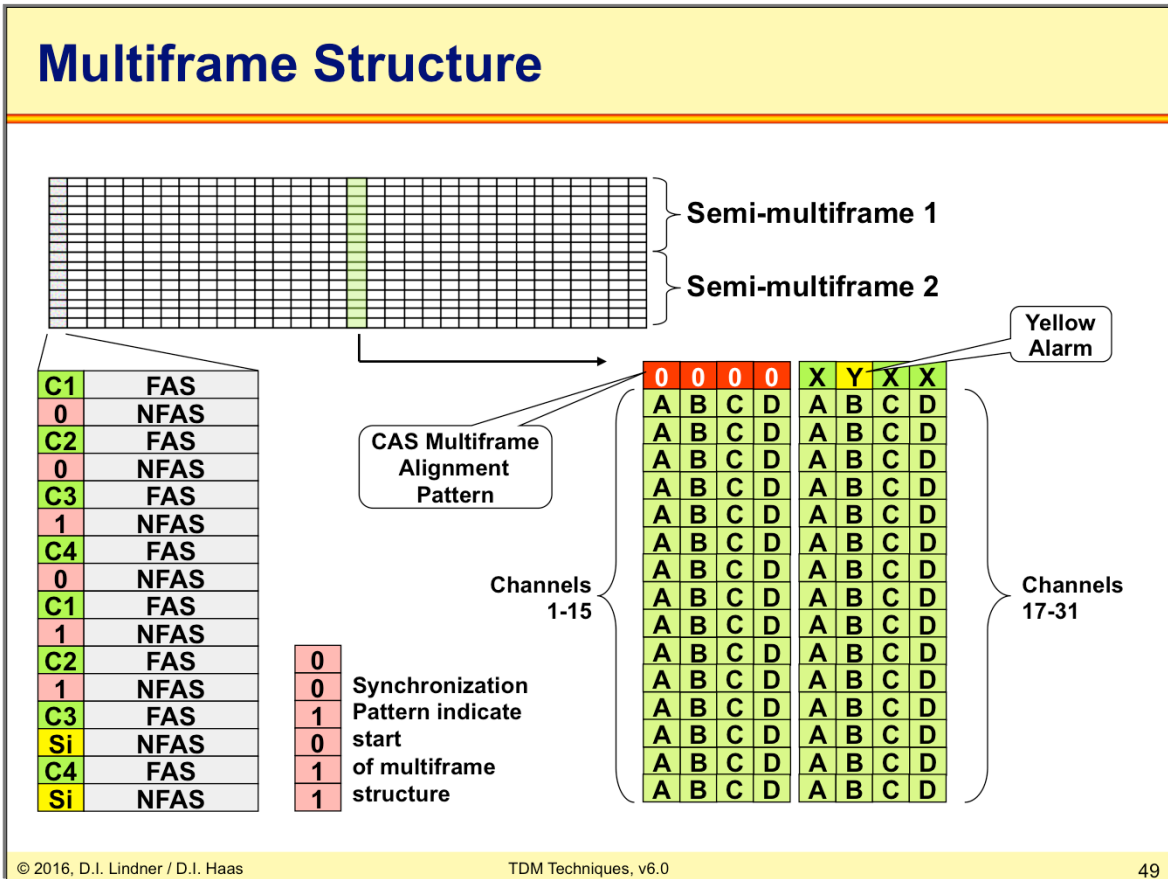

Frame synchronization, optional CRC checks, and CAS is only possible when viewing the big picture, that is, viewing a number of frames at once. A so-called "multiframe structure" consists of 16 consecutive frames and are regarded as two-dimensional arrays.

A multiframe consists of two "semi-multiframes", whereas semi-multiframe 2 contains 4 CRC bits that protect semi-multiframe 1.

The Si bits are used to report CRC errors to the remote station

L03 - TDM Techniques (v6.0)

T1 Basics

- **T1 is the North American PDH variant**
 - DS0 is basic element
- **24 timeslots per T1 frame**
= 1.544 Mbit/s

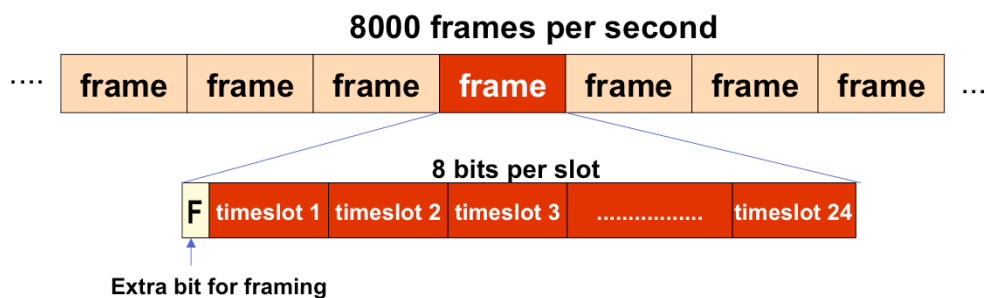

In North America the PDH technology also originated from digital voice transmission. Here the so-called T1 is the equivalent to the European E1. The "T" stands for "Trunk". But T1 and E1 are not compatible because the T1 consists of 24 timeslots only.

Also encoding and physics is different:

AMI or B8ZS (Bipolar 8 Zero bit Suppression)

100 ohm, twisted pair

The timeslots are numbered 1-24 whereas one timeslot can carry 8 bits. Only one extra bit is for framing. The total frame length is 193 bits. Since the frame repetition rate must also be 8000 Hz the resulting data rate is: $(24 \times 8 + 1) \times 8000 = 1.544 \text{ Mbit/s}$.

L03 - TDM Techniques (v6.0)

T1 Basics

- **Combinations of frames to superframes**
 - 12 T1 frames (DS4)
 - 24 T1 frames (Extended Super Frame, ESF)
- **No reserved timeslot for signaling → Robbed Bit Signaling**
 - No Problem for PCM
 - Problem for data -> only 56kbit/s usable
- **Modern alternative: Common Channel Signaling**

One framing bit is not sufficient for frame synchronization, therefore framing bits of consecutive frames are combined to form a multiframe synchronization pattern. The multiframe structure is called superframe.

D4 format

- 12 frames are combined to one superframe (SF)
- 12 consecutive framing bits are 100011011100
(1200 bits/s used for synchronization)

ESF format

- 24 frames are combined to one extended superframe (ESF)
- 6 framing bits (2000bit/s) are used for synchronization in frames 4, 8, 12, 16, 20, 24 (pattern 001011)
- 6 framing bits (2000 bit/s) may be used for CRC error checking in frames 2, 6, 10, 14, 18, 22
- 12 framing bits (4000 bit/s) may be used for a diagnostic channel in all odd numbered frames

T1 framing is often used to connect PBX (Private Branch Exchanges) via leased line hence the signaling information between PBXs must be exchanged. But T1 defines no dedicated timeslot for CAS, instead "robbed bit signaling" is used.

Robbed Bit Signalling does not affect PCM signals (analog sources) but damages data channels completely!

Therefore only 56 kbit/s data channels are possible with CAS. Alternatively, CCS can be used in the same way like E1. For example timeslot 24 can be used as transparent signaling channel. In the USA, ISDN is typically carried over CAS systems because there is still a lot of old equipment used across the country. So only 56 kbit/s per B channel usable. 64 kbit/s B channels would require CCS, which is also called "Clear Channel Capability (CCC)".

L03 - TDM Techniques (v6.0)

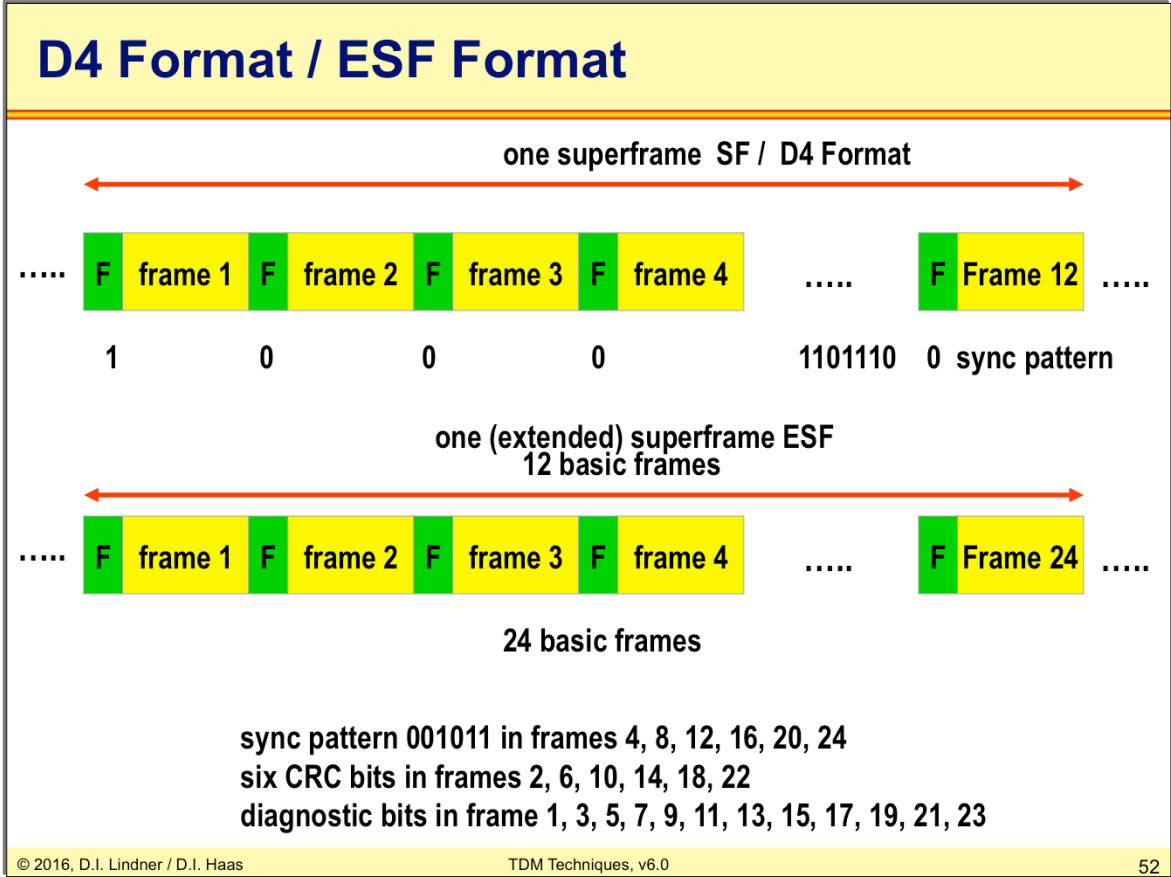

L03 - TDM Techniques (v6.0)

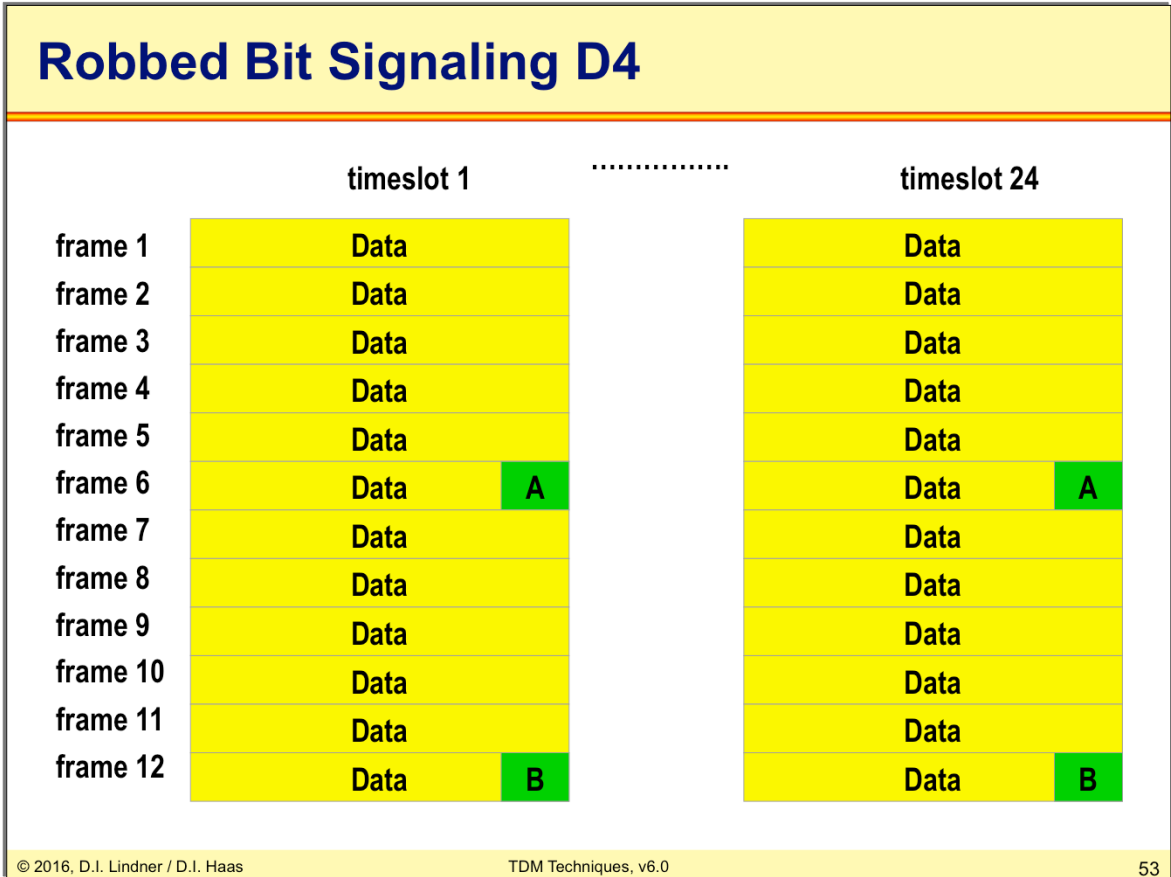

Using CAS the signaling information is transmitted by robbing certain bits, which are normally used for data. The signaling is placed in the LSB of every time slot in the 6th and 12th frame of every D4 superframe (A, B).

L03 - TDM Techniques (v6.0)

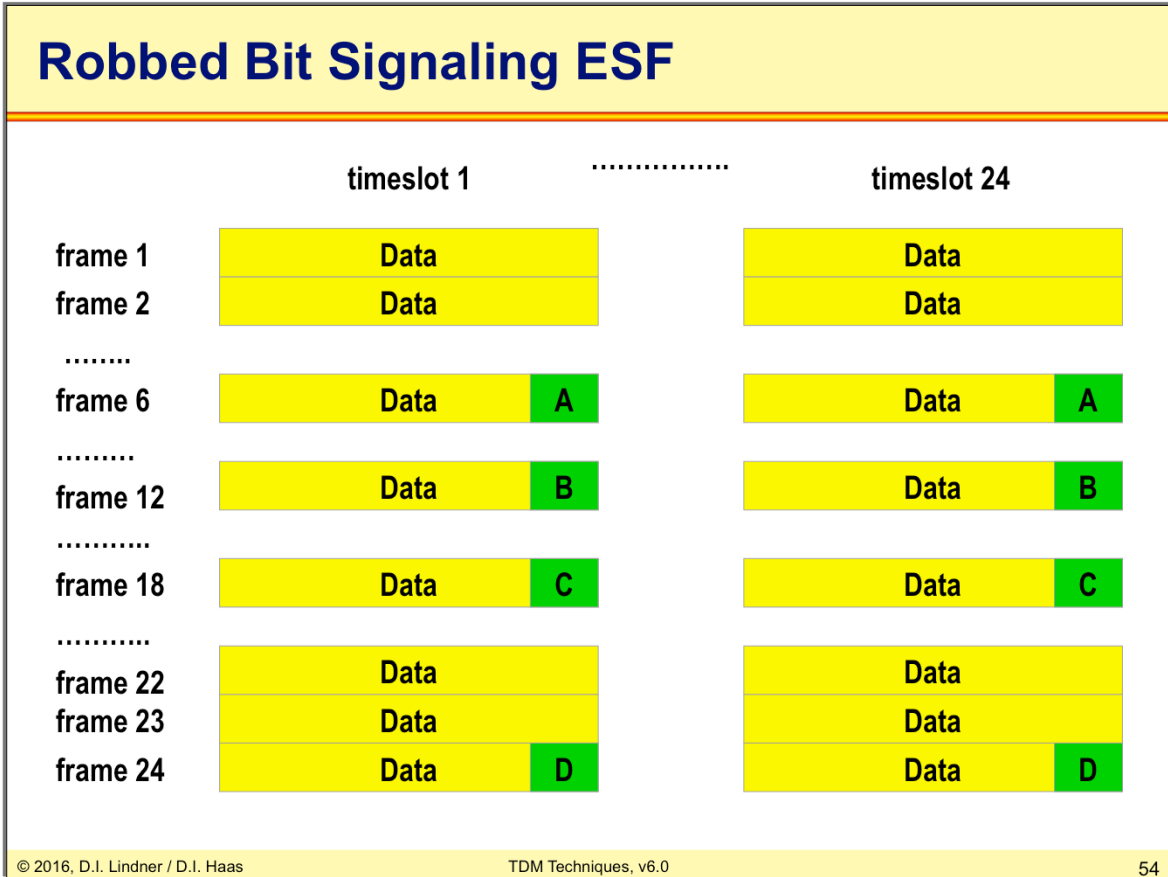

Using an Extended Super Frame (ESF) structure, the signaling information is placed in the LSB of every time slot in the 6th, 12th 18th and 24th frame of every ESF superframe (A, B, C, D).

L03 - TDM Techniques (v6.0)

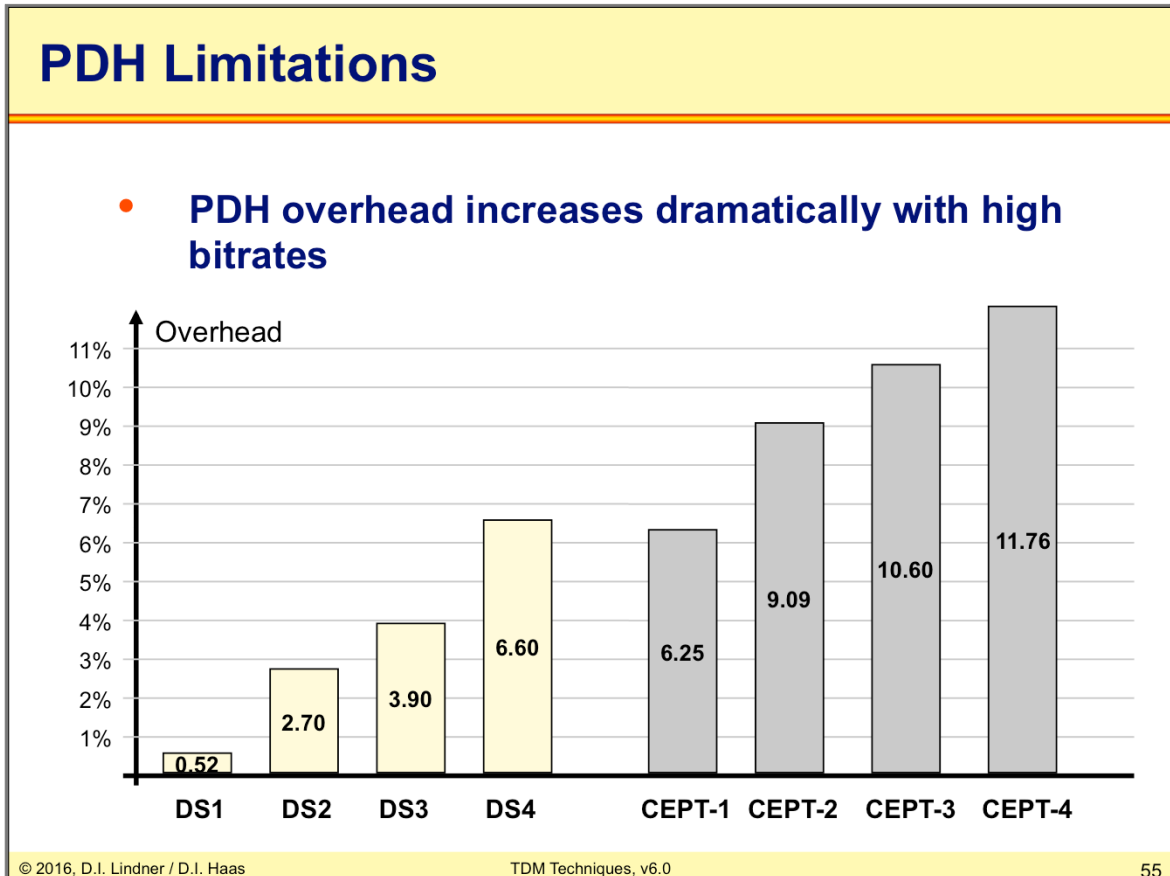

The diagram above shows one of the main disadvantages of PDH technologies: the overhead increases significantly with the data rate, i. e. multiplex level. Thus it is not reasonable to create much higher signal levels with this technology.

Note that the North American bit robbing method has also one advantage: the total overhead is much lower compared to the European PDH variant.

L03 - TDM Techniques (v6.0)

Agenda

- **Introduction**
- **Synchronous (Deterministic) TDM**
- **Asynchronous (Statistical) TDM**
- **Telco Backbones**
 - Digital Voice Transmission
 - PDH
 - SDH

L03 - TDM Techniques (v6.0)

Reasons for SONET/SDH Development

- **Incompatible PDH standards !!!**
- **PDH does not scale to very high bit rates**
 - Increasing overhead
 - Various multiplexing procedures
 - Switching of channels requires demultiplexing first
- **Demand for a true synchronous network**
 - No pulse stuffing between higher MUX levels
 - Phase shifts are compensated by floating payload and pointer technique
- **Demand for add-drop MUXes and ring topologies**

In the early 1980s there was a big demand for another backbone technology because of the severe drawbacks of the old PDH technology.

During the decades, many different PDH implementations were built by different vendors. Furthermore PDH does not scale to high data rates because of the overhead problem and because of the complex multiplexing method.

One thing was clear: A successor of PDH—which was supposed to scale up to infinite data rates—must be truly synchronous. Also flexible topology configurations should be possible.

L03 - TDM Techniques (v6.0)

SDH History

- After divestiture of AT&T
 - Many companies -> many proprietary solutions for PDH successor technology
- In 1984 ECSA (Exchange Carriers Standards Association) started on SONET
 - Goal: one common standard
 - Tuned to carry US PDH payloads
- In 1986 CCITT became interested in SONET
 - Created SDH as a superset
 - Tuned to carry European PDH payloads including E4 (140 Mbit/s)
- SDH is a world standard
 - SONET is subset of SDH
- Originally designed for fiber optics

In 1984 the Exchange Carriers Standards Association (ECSA) started on the development of "Synchronous Optical Networks", short: SONET. The goal was to define one common standard for all companies that were born after the divestiture of AT&T. Over 400 proposals were sent; but finally, after a long negotiation period, the SONET standards was born and became an ANSI standard.

First US nation-wide SONET ring backbone were finished in 1997.

In 1986 the CCITT (now ITU-T) became interested in SONET and defined the "Synchronous Digital Hierarchy" (SDH) as a superset of SONET. Now SDH is the world standard and SONET is considered as a subset of SDH.

SDH was first published in the CCITT "Blue Book" in 1989, specifying the interfaces and methods G.707, G.708, G.709, and many more.

L03 - TDM Techniques (v6.0)

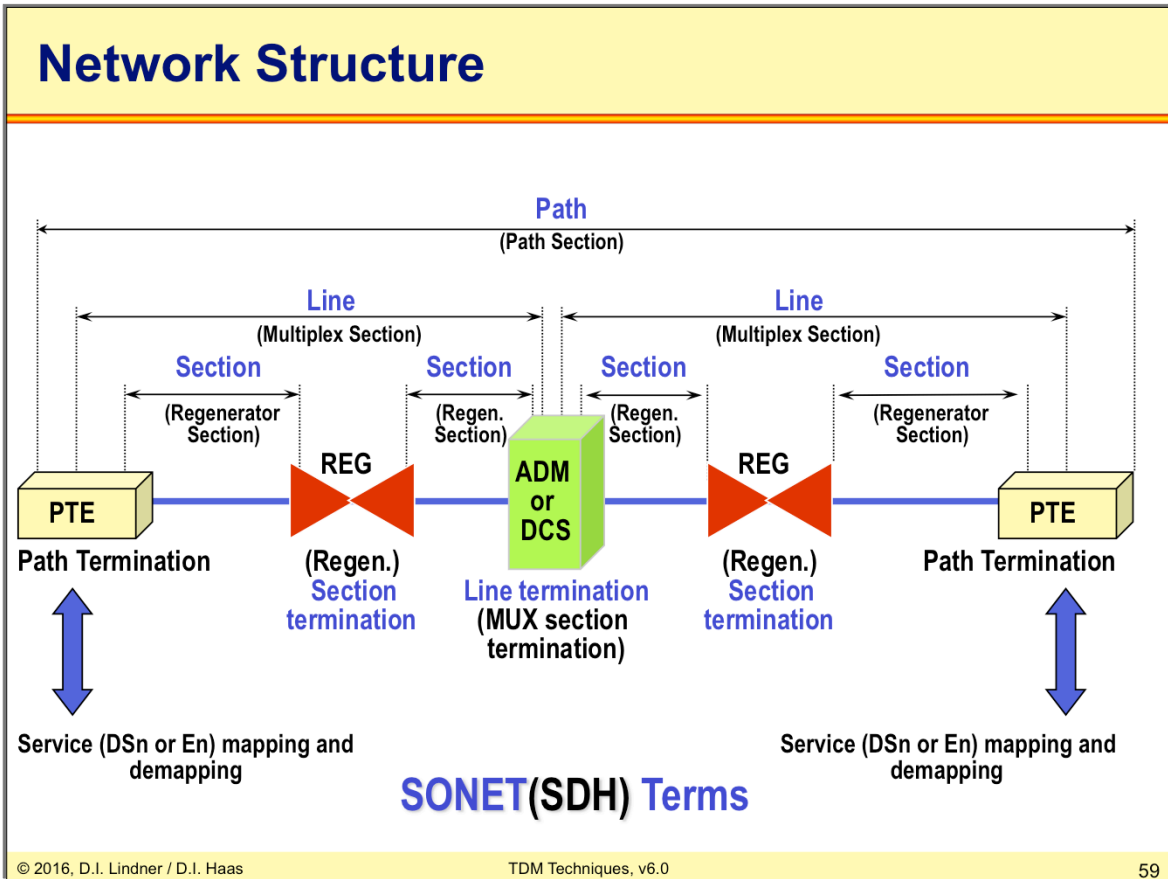

The picture above shows the network structure of a SONET/SDH network. Although SONET and SDH are compatible, note the slightly different terms between both worlds.

The "Terminal Multiplexer" represents a so-called "Path Termination" and marks the edge of the SONET/SDH network (Path) by providing connectivity to the PDH network devices. A Path is an end-to-end connection between those Terminal Multiplexers. The "Regenerator" extends the possible distance and quality of a "Line". The Line spans between a Path termination and a network node, for example an ADM or DCS. The Regenerator splits a line into multiple Sections.

The Add/drop multiplexer (ADM) is the main element for configuring paths on top of line topologies (point-to-point or ring). Using an ADM it is possible to add or drop multiplexed channels.

The Digital Cross Connect (DCS or DXC) is named after the historical patch panels used in the early analog backbones. This device is basically a "static switch" and connects equal-level channels with each other.

L03 - TDM Techniques (v6.0)

SONET/SDH Line Rates

SONET Optical Levels	SONET Electrical Level	Line Rates Mbit/s	SDH Levels	
OC-1	STS-1	51.84	STM-0	
OC-3	STS-3	155.52	STM-1	
OC-9	STS-9	466.56	STM-3	
OC-12	STS-12	622.08	STM-4	
OC-18	STS-18	933.12	STM-6	Defined but later removed, and only the multiples by four were left!
OC-24	STS-24	1244.16	STM-8	
OC-36	STS-36	1866.24	STM-12	
OC-48	STS-48	2488.32	STM-16	
OC-96	STS-96	4976.64	STM-32	
OC-192	STS-192	9953.28	STM-64	
OC-768	STS-768	39813.12	STM-256	(Coming soon)

The chart above shows all current SONET/SDH signal levels.

SDH STM-0 frame is compatible with SONET STS-1 and has the same frame size. Originally this was only thought for comparisons but recently it becomes a real-life frame format for microwave links.

Higher level frames can be defined simply by multiplying STS-1 and STM-1 frame sizes by a certain factor. Only a few of them are available in the real world. Frames are strictly byte oriented and byte multiplexed.

L03 - TDM Techniques (v6.0)

Uni- and Bi-directional Routing

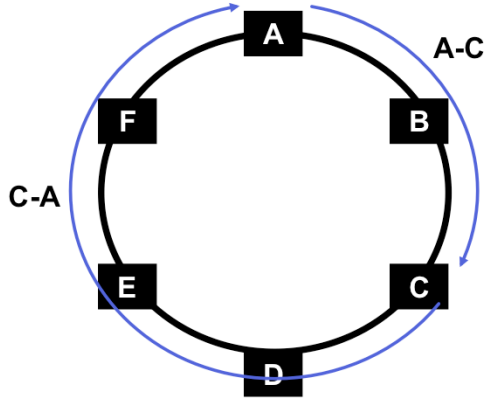

**Uni-directional Ring
(1 fiber)**

- Only working traffic is shown
- Path or line switching for protection

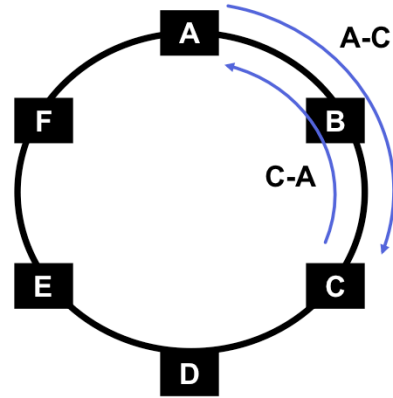

**Bi-directional Ring
(2 fibers)**

Bidirectional rings provide much more performance over unidirectional rings. Note that light signals are typically only sent unidirectional through one fiber because of technical simplicity.

L03 - TDM Techniques (v6.0)

SDH Operations

- **Protection**
 - Circuit recovery in milliseconds
- **Restoration**
 - Circuit recovery in seconds or minutes
- **Provisioning**
 - Allocation of capacity to preferred routes
- **Consolidation**
 - Moving traffic from unfilled bearers onto fewer bearers to reduce waste trunk capacity
- **Grooming**
 - Sorting of different traffic types from mixed payloads into separate destinations for each type of traffic

SONET/SDH topologies are designed for providing a flexible and reliable transport for required paths. Capacity planning and bandwidth provisioning is still a research issue. Redundancy and automatic fail-over is provided within 20 ms. Delay and jitter control through control signals.

Typical topology concepts:

Point-to-point links (with protection) and DCS/MUX allows arbitrary complex topology to be built.

Interconnected protected rings with ADM/DCS allow for minimum resource usage (physical media) for avoiding single point of failures.

L03 - TDM Techniques (v6.0)

SONET/SDH and the OSI Model

- **SONET/SDH covers**
 - Physical, Data Link, and Network layers
- **However, in data networking it is used mostly as a transparent bit stream pipe**
- **Therefore SONET/SDH is regarded as a Physical layer, although it is more**
- **Functions might be repeated many times in the overall protocol stack**

Note that SONET/SDH layers cannot be easily compared with OSI layers. Actually SONET/SDH links are often used as "physical layer" for several OSI compliant protocols or even the Internet protocol.